

# ZXM-GIM20

## USER MANUAL



ZERO-X



# CONTENTS

<b>1.0</b>	<b>ABOUT THE ZXM-GIM20 .....</b>	<b>5</b>
<b>2.0</b>	<b>WHATS IN THE BOX.....</b>	<b>5</b>
<b>3.0</b>	<b>COMPONENTS .....</b>	<b>5</b>
<b>4.0</b>	<b>GETTING STARTED .....</b>	<b>6</b>
4.1	UNFOLD THE ZXM-GIM20.....	6
4.2	FIT YOUR SMARTPHONE TO THE ZXM-GIM20.....	6
4.3	FOLDING THE ZXM-GIM20.....	7
<b>5.0</b>	<b>HOW TO CHARGE YOUR ZXM-GIM20.....</b>	<b>7</b>
5.1	TO START .....	7
5.2	HOW TO CALIBRATE THE ZXM-GIM20.....	8
<b>6.0</b>	<b>ZXM-GIM20 CONTROLS AND FUNCTIONS.....</b>	<b>8</b>
6.1	POWER BUTTON / MANUAL BUTTON:.....	8
6.2	CAMERA SHUTTER BUTTON: .....	8
6.3	BATTERY LEVEL INDICATOR: .....	9
6.4	MODE INDICATOR .....	9
6.5	JOYSTICK .....	10
6.6	ZOOM AND FOCUS SLIDER .....	10
6.7	TRIGGER BUTTON .....	11
6.8	USING THE LANYARD HOLE .....	11
6.9	¼ INCH THREADED HOLE.....	11
<b>7.0</b>	<b>FUNCTIONS .....</b>	<b>11</b>
<b>8.0</b>	<b>ORIENTATIONS .....</b>	<b>12</b>
8.1	STANDARD .....	12
8.2	UNDERSLUNG .....	12
8.3	INCEPTION .....	12

9.0	INSTALLING AND USING THE ZERO-X GIMBAL APP .....	13
10.0	MANUAL STEPS FOR CONNECTING TO THE ZERO-X GIMBAL APP .....	13
11.0	ZERO-X GIMBAL APP MAIN USER SCREEN ....	14
12.0	UPGRADE YOUR FIRMWARE .....	17
13.0	SPECIFICATIONS .....	17
14.0	WARRANTY .....	18

## 1.0 ABOUT THE ZXM-GIM20

The ZXM-GIM20 has been designed to turn your smartphone into a stable, smooth and lightweight 3 axis-camera. High-precision motors and aerospace-grade aluminium arms make this gimbal exceptionally stable. Your smartphone's camera can smoothly transition between portrait and landscape while filming and the gimbal can be folded in half and easily transported.

## 2.0 WHATS IN THE BOX

1 x ZXM-GIM20 Gimbal	1 x Quick Start Guide
1 x USB Charging Cable	1 x User Manual
1 x Mini Tripod	

## 3.0 COMPONENTS

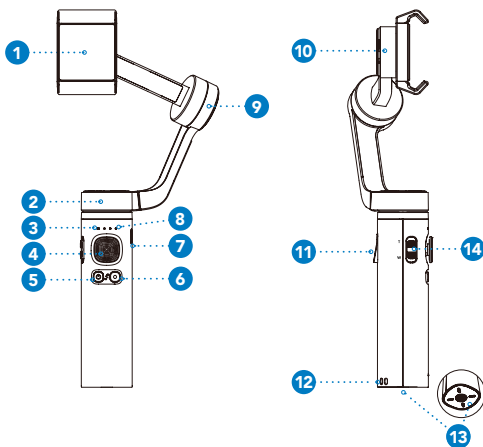

- |                               |                            |
|-------------------------------|----------------------------|
| 1. Smartphone clamp           | 8. Battery level indicator |
| 2. Yaw motor                  | 9. Pitch motor             |
| 3. Mode indicator             | 10. Roll motor             |
| 4. Joystick                   | 11. Trigger button         |
| 5. Power/ Mode button         | 12. Lanyard Mount          |
| 6. Shutter button             | 13. ¼ inch threaded hole   |
| 7. Charging port (USB Type-C) | 14. Zoom slider            |

## 4.0 GETTING STARTED

Make sure your smartphone and ZXM-GIM20 are fully charged and you have the App installed, running and the gimbal and your smartphone are connected via Bluetooth (see QR code and instructions on page 13).

### 4.1 UNFOLD THE ZXM-GIM20

To operate the ZXM-GIM20, start by unfolding it. To do this, hold the handle with one hand as shown. Rotate the gimbal arm by 180° degrees (as shown). It is normal for the arm to be stiff during first use. When you hear a click, this means the gimbal is unfolded.

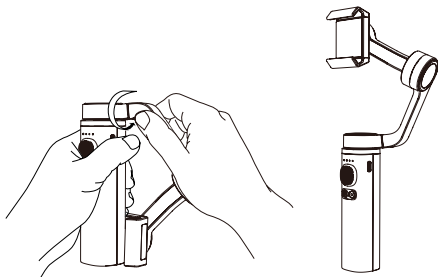

Rotate to unfold

Unfolded

### 4.2 FIT YOUR SMARTPHONE TO THE ZXM-GIM20

Open the clamps and fit your smartphone to the gimbal with the screen facing towards you and the gimbal motor to the right. If your smartphone has a cover, please remove it to fit your smartphone comfortably in the clamp.

**CAUTION:** Please ensure your smartphone is attached to the ZXM-GIM20 before you turn the gimbal on.

### 4.3 FOLDING THE ZXM-GIM20

To fold the ZXM-GIM20 back into position, rotate the gimbal arm again by 180° in the direction shown. Adjust the smartphone clamp, as necessary.



Rotate to fold

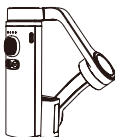

Folded

**NOTE:** Make sure the ZXM-GIM20 is powered off when you fold or unfold it.

### 5.0 HOW TO CHARGE YOUR ZXM-GIM20

To charge the ZXM-GIM20, use the USB Type-C port and the provided USB-C charging cable. You can charge the ZXM-GIM20 via wall charger, car charger or computer USB port. (Not provided). The battery level will be indicated by progressive white lights (i.e more lights more battery, less lights less battery).



- Charging time: Approx. 3-4 hours (With 5V 2A power adaptor).
- Operating time: Approx. 12 hours.
- Charging port (USB Type-C).

### 5.1 TO START

1. To use the ZXM-GIM20 gimbal you will need to unfold it as instructed.
2. Secure your smartphone to the clamp.

**NOTE:** The clamp needs to be 5mm to the right of the centre of your smartphone to achieve balance. The smartphone camera should always be to the left of the clamp.

3. To turn on the gimbal, press and hold the power button for three seconds.

Your smartphone needs to be balanced for the ZXM-GIM20 gimbal to maneuver it.

## 5.2 HOW TO CALIBRATE THE ZXM-GIM20

The first time you use the ZXM-GIM20 it is best to calibrate it.

To calibrate the ZXM-GIM20, tap the calibration button in the App and wait for 15 seconds. The gimbal will automatically calibrate, turn off and restart.

## 6.0 ZXM-GIM20 CONTROLS AND FUNCTIONS

### 6.1 POWER BUTTON / MANUAL BUTTON:

- When power is OFF, tap the ON/OFF button once to view the gimbal's battery level, which is shown by round LED lights. If all three LED's are on, it indicates the gimbal is fully charged.
- When power is ON, tap the ON/OFF button once to switch the smartphone camera between portrait and landscape.
- Tap the ON/OFF button twice to switch between Follow and FPV mode. You will find the 'F' change to 'FPV' (near the battery level in the top right corner of the App) which indicates either Follow mode or FPV mode.
- To switch to Inception Mode, tap the ON/OFF button three times.
- Press the OFF button for three seconds to completely turn off ZXM-GIM20.

### 6.2 CAMERA SHUTTER BUTTON:

Depending on the chosen mode (i.e- photo or video) a single tap will take a photo or start / stop recording.

- **Double tap:** Switch between the front or rear camera (when using the App).
- **Press and hold:** Switch between photo / video mode.



### 6.3 BATTERY LEVEL INDICATOR:

The round LED lights indicate the battery level of the gimbal. One light means the battery level is low and three lights means the battery level is nearly full or full.

### 6.4 MODE INDICATOR

The ZXM-GIM20's function is indicated by flickering lights, as set out below.

Mode Indicator Status	Gimbal Mode	Triggered By	Description
Solid green light	Follow	Default	Your smartphone camera will follow the pitch and yaw of the ZXM-GIM20 smoothly. During this mode, the roll movement is locked.
Flashing green light	Phone GO	Quickly press the trigger button once, then press again and hold	Best for filming sporting events, the ZXM-GIM20 gimbal will move your smartphone quickly to record. Response time of the gimbal will reduce and sensitivity will increase.
Solid blue light	FPV	Double tap the power button	This mode is best for first-person-view. Your smartphone will follow the pitch and yaw of the gimbal.
Flashing blue light	Inception	Triple tap the power button	This mode is best suited to record a 360° view. The gimbal will lock in a roll, pitch and yaw movement. The joystick can be used to control the pitch and roll of the gimbal.
Solid red light	Lock	Press and hold the trigger button	In this mode, the camera does not follow the movement of the gimbal. However, the joystick can be used to control the pitch and yaw of the gimbal. This mode is used when shooting linear movements.
Flashing red light	Gimbal Motor Protection	Malfunction button	When flickering, this is a clear sign that the ZXM-GIM20 is malfunctioning. Turn off the gimbal and reset.

## 6.5 JOYSTICK

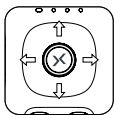

Move up and down to control the gimbal pitch.

Move left and right to control the gimbal yaw.

**BEGINNERS TIP:** The three axes of rotation in the ZXM-GIM20, as controlled by the joystick, are referred to as pitch, roll and yaw. When the joystick is used, the default movement of your smartphone will appear opposite to what is intended. However, the gimbal is moving your smartphone to orientate the camera to the intended position. This can be changed through gimbal settings in the App.

## 6.6 ZOOM AND FOCUS SLIDER

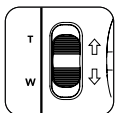

### One slider two functions:

This slider can be used to either control the zoom or focus ability of your smartphone's camera.

To set and designate the slider to either zoom or focus, please log into your Zero-X Gimbal App.

- **Slider function when in Zoom mode:**

Push W to zoom out and T to zoom in.

- **Slider function when in Focus mode:**

Push the slider up and down to control focus settings.

The user can also manage the tracking focus option in the App. Please refer to the App section in this manual for more details.

## 6.7 TRIGGER BUTTON

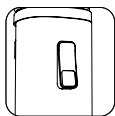

This button can be used to do the following:

- Lock the ZXM-GIM20 (press and hold down).
- Release the ZXM-GIM20 and return to default (release the trigger).
- Return ZXM-GIM20 to neutral position (press twice).
- Put ZXM-GIM20 into PhoneGo mode (quickly press once, then press again and hold).

## 6.8 USING THE LANYARD HOLE

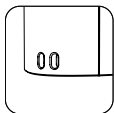

Thread the lanyard through the holes as shown in diagram. Please note the lanyard is not provided.

## 6.9 1/4 INCH THREADED HOLE

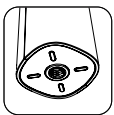

This 1/4 inch threaded hole has been designed to allow you to mount the included mini tripod, an extension arm or other ZXM-GIM20 accessories. Your ZXM-GIM20 comes with a mini tripod.

## 7.0 FUNCTIONS

The ZXM-GIM20 has several photography functions for use to take photos or shoot videos. To use these functions, please open to the App. These functions are described on page 14.

## 8.0 ORIENTATIONS

### 8.1 STANDARD

The ZXM-GIM20 can be used in a standard, upright position.

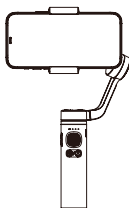

### 8.2 UNDERSLUNG

If you hold the ZXM-GIM20 upside down, it will transition to 'underslung' mode and will record footage close to the ground.

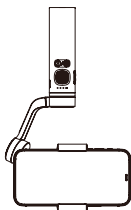

### 8.3 INCEPTION

Inception mode allows you to take great spinning 360° shots. To use this mode, tap the power button (quickly) three times.

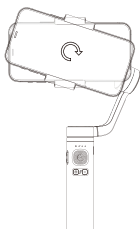

## 9.0 INSTALLING AND USING THE ZERO-X GIMBAL APP

Please scan the below QR code.

OR

Please search the App Store for 'Zero-X Gimbal'.



The Zero-X Gimbal App requires iOS 11.0 and above on iPhone or Android 7.0 device to run.

## 10.0 MANUAL STEPS FOR CONNECTING TO THE ZERO-X GIMBAL APP

1. Turn on your phone and scan the QR code or search the App store for Zero-X Gimbal and download the App.
2. Turn on Bluetooth on your phone and run the Zero-X Gimbal App. Connect to the device called ZXM-GIM20. Once opened, the App should prompt you to connect to Bluetooth, or alternatively you can press the Bluetooth icon on the screen to connect.
3. After Bluetooth is connected successfully, you can control the smartphone camera and gimbal from the App.



## 11.0 ZERO-X GIMBAL APP MAIN USER SCREEN



### 1. Home

Press to go back to the home page.

### 2. Bluetooth Connection Status

Indicates the current operation mode of the ZXM-GIM20.

If Bluetooth is not connected or loses connection there will be a cross through this icon. Please re-connect to Bluetooth to operate the ZXM-GIM20.

### 3. Gimbal Operating Mode

Indicates the current operating mode of the ZXM-GIM20.

### 4. Gimbal Battery Level

As shown by the battery icon on the App screen.

### 5. Smart Tracking Indicator

Smart tracking has two modes: face tracking and object tracking.

**Face / Object Tracking Mode:** The Zero-X Gimbal App will recognise the closest face or object and calibrate the ZXM-GIM20 gimbal to follow it.

**BEGINNERS TIP:** A green, rectangle frame will appear in the Zero-X Gimbal App once a face or object has been identified. If the object or face is not recognised the rectangle will become red, and you will need to start the tracking recognition process again.

To stop tracking, press the cross icon on the top right-hand corner of the rectangle.

## 6. Gesture Control Mode

This mode allows you to make certain hand gestures that will help control functions of the camera.

Recognised gestures:

- **Scissor Gesture:** 3 second delay before photo is taken.
- **Palm Gesture:** The camera will switch between photo and video mode.

## 7. Shooting Modes / Functions

Slide to select different shooting modes:

- **Panorama:** There are three sub-modes: 180°, 320° and 3x3 modes. In 180° mode 3 photos are taken and fused together. In 320° mode, 8 photos are taken and fused together. In 3x3 mode, 9 photos are taken and fused together.
- **Photo:** Takes a single photo or is used as a timer.
- **Video:** Shoots a video.
- **Beauty Mode:** Allows for softer lights and filters.
- **Slow-Motion:** Shoots 8 times slower than usual.
- **Timelapse:** There are 2 sub-modes – static timelapse and waypoint lapse.

When in static Timelapse Mode, select the interval and time length on the top of the screen and press the record icon. In this mode, you can also use the tracking feature, while shooting timelapse videos simultaneously.

When in Timelapse Mode, besides the interval and time length, the user can also set up to 5 waypoints by using the joystick.

The ZXM-GIM20 will move to the pre-selected waypoints in sequence after shooting starts.

In Hyperlapse mode, only motion will be recorded by the ZXM-GIM20.

## 8. Shutter

This button will take photos or begin recording.

## 9. Album

Access your footage and photos.

## 10. Switch between front and rear camera

As the name suggests, easily transition between both viewpoints.

## 11. Switch between Zoom or Focus Mode

'Z' stands for 'zoom'. In this mode, the slider on the gimbal controls the zoom of the image. 'F' stands for 'focus'. In this mode, the slider on the ZXM-GIM20 controls the focus of the image.

## 12. Settings

**Camera settings:** In this setting you can set flashlights, grids and image aspect ratios.

- **Joystick sensitivity:** You can adjust the sensitivity of the joystick. The user can also reverse the up/ down and left/ right control of the joystick.

## 13. Parameters of the ZXM-GIM20 App

- **The image resolution for panorama:** There are 3 grades: low, medium and high. If necessary, try reducing the image resolution setting in your smartphone to improve the quality of your panorama shot.
- **Calibrating sensors:** If the gimbal starts to drift slowly, press this icon to calibrate the sensors. Reboot the ZXM-GIM20 after calibration.
- **Horizontal adjustment:** Calibrate the horizon of the ZXM-GIM20.
- **Live Face tracking:** Enable live face tracking while using other streaming apps.
- **Firmware upgrade:** Press to upgrade the firmware of the ZXM-GIM20. When there is a blue dot on this icon, an upgrade to the latest firmware version is required.



## 12.0 UPGRADE YOUR FIRMWARE

Check the battery level has capacity for the upgrade. It should show 2 lights or more.

Connect to Bluetooth, select 'firmware upgrade' from the menu at the left side of the App interface to start.

Please keep note of the progress bar during the upgrade.

Do not quit the app or minimise the App until the upgrade is complete.

The ZXM-GIM20 will turn off once the upgrade has finished.

Turn on the ZXM-GIM20 manually. If the upgrade fails, please reboot the ZXM-GIM20 and reopen the Zero-X Gimbal App and try again.

## 13.0 SPECIFICATIONS

Specification	Gimbal
Model	ZXM-GIM20
Dimension	Unfolded: 254 x 129 x 41mm Folded: 140 x 116 x 64mm
Weight	320g
Mechanical Range	Pitch: 300° Roll: 300° Yaw: 300°
Allowable Phone Weight	130-300g
Allowable Phone Thickness	6.9 - 11mm
Applicable model phone width	67 - 92mm
Working Voltage	5V
Battery Capacity	4500mAh
Charging Time	3-4 Hours
Operating Time	12 Hours (under balanced conditions)

## 14.0 WARRANTY

### WARRANTY TERMS & CONDITIONS

Our goods come with guarantees that cannot be excluded under the Australian Consumer Law. You are entitled to a replacement or refund for a major failure and for compensation for any other reasonably foreseeable loss or damage. You are also entitled to have the goods repaired or replaced if the goods fail to be of acceptable quality and the failure does not amount to a major failure.

This warranty is provided in addition to your rights under the Australian Consumer Law. Directed Electronics Australia Pty Ltd (Directed Electronics) warrants that this product is free from defects in material and workmanship for a period of 12 months from the date of purchase or for the period stated on the packaging. This warranty is only valid where you have used the product in accordance with any recommendations or instructions provided by Directed Electronics.

This warranty excludes defects resulting from alterations of the product, accident, misuse, abuse or neglect. In order to claim the warranty, you must return the product to the retailer from which it was purchased or if that retailer is part of a National network, a store within that chain, along with satisfactory proof of purchase. The retailer will then return the goods to Directed Electronics.

Directed Electronics will repair, replace or refurbish the product at its discretion. The retailer will contact you when the product is ready for collection. All costs involved in claiming this warranty, including the cost of the retailer sending the product to Directed Electronics, will be borne by you.

**Email:** [admin@zero-x.com.au](mailto:admin@zero-x.com.au)

## **INDEMNITY**

You agree to defend, indemnify and hold harmless Zero-X and its subsidiaries and affiliates from and against any and all claims, proceedings, injuries, liabilities, losses, costs and expenses (including reasonable legal fees), including but not limited to, claims alleging negligence, invasion of privacy, copyright infringement and/or trademark infringement against Zero-X and its subsidiaries and affiliates, relating to or arising out of your breach of any provision of these terms, your misuse of Zero-X or its services, or your unauthorized modification or alteration of products or software.

## **WARRANTY AND WARRANTY DISCLAIMER**

Zero-X has a limited warranty, whereby Zero-X warrants to you and only to you that this Zero-X gimbal will be free from defects in materials and workmanship for one (1) year from the date of your purchase (unless a longer warranty period is required by law). The specifics of this Zero-X limited warranty are covered in this manual.

To the extent possible under governing law, other than the above product warranty for the Zero-X Gimbal you understand and agree that the Zero-X services are provided on an "as is" and "as available" basis.

Zero-X makes no warranty that the Zero-X product and services will meet your requirements or that use of the Zero-X services will be uninterrupted, timely, secure or error-free. Nor does Zero-X make any warranty as to the accuracy or reliability of any information obtained through the Zero-X (including third party content), that any defects in the Zero-X will be corrected or that the Zero-X products or Zero-X services will be compatible with any other specific hardware or service. Further, Zero-X does not warrant that the Zero-X or the Zero-X servers that provide you with data and content are free of viruses or other harmful components.

Zero-X also assumes no responsibility for and shall not be liable, for any damages caused by viruses that may infect your Zero-X.

In the event of any loss, damage or injury, you will not look to Zero-X to compensate you or anyone else. You release and waive for yourself and your insurer all subrogation and other rights to recover against Zero-X arising as a result of the payment of any claim for loss, damage or injury.

Zero-X equipment and services do not cause and cannot eliminate occurrences of certain events, including, and Zero-X makes no guarantee or warranty, including any implied warranty of merchantability or fitness for a particular purpose, that the Zero-X equipment and services provided will detect or avert such incidents or their consequences.

Zero-X does not undertake any risk that you or property, or the person or property of others, may be subject to injury or loss if such an event occurs. The allocation of such risk remains with you, not Zero-X.

Other than the above product warranty for the Zero-X, its suppliers disclaim all warranties of any kind, whether express, implied, or statutory, regarding the Zero-X services, including any implied warranty of title, merchantability, fitness for a particular purpose, or noninfringement of third party rights.

Because some jurisdictions do not permit the exclusion of implied warranties, the last sentence of this section may not apply to you. Zero-X hereby further expressly disclaims all liability for any claims for service failures that are due to normal product wear, product misuse, abuse, product modification, improper product selection or your non-compliance with all applicable federal, state or local laws.

This warranty and warranty disclaimer give you specific legal rights, and you may have other rights that vary by state, province, or country. Other than as permitted by law, Zero-X does not exclude, limit or suspend other rights you have, including those that may arise from the nonconformity of a sales contract.

For a full understanding of your rights, you should consult the laws of your state, province, or country. For our Australian customers: Please note that this warranty is in addition to any statutory rights in Australia in relation to your goods which, pursuant to the Australian Consumer Law, cannot be excluded.

## LIMITATIONS OF ZERO-X LIABILITY

Under no circumstances will Zero-X be liable in any way for any content, including, but not limited to, the loss of content, any errors or omissions in any content, or any loss or damage of any kind incurred in connection with use of or exposure to any content posted, emailed, accessed, transmitted, or otherwise made available via Zero-X.

Zero-X liability for damages, especially for breach of duty or obligation, delay in performance, non-performance, or malperformance shall be precluded, except when these are due to negligent breaches of any significant contractual duty or obligation on the part of Zero-X. Any liability for negligence is limited to direct losses usually and typically foreseeable in such case. Should the claim for damages be based on wilful or grossly negligent breach of contractual duty or obligation on the part of Zero-X, the preclusion and limitation of liability mentioned in the preceding sentences will not apply. The preceding preclusion and limitation of liability will also not apply to claims for damages arising out of loss of life, bodily injury or health impacts for which Zero-X may be liable, or for non-contractual liability.

Some states and countries do not allow the exclusion or limitation of incidental or consequential damages, so the above limitation or exclusion may not apply to you. Additionally, this provision is not intended to limit Zero-X's liability in the event of Zero-X's wilful or intentional misconduct.





Capture the action.™

**ZERO-X**

ANOTHER  
DIRECTED  
BRAND



All Images, Information and Content are  
Copyright © 2022 Directed Electronics  
Australia Pty Ltd. All Rights Reserved.