

stratus

USER MANUAL



22 MIN
Flight Time

600 M
Flight Range

4K
Video

AUTOPILOT
NAVIGATION

AUTO
GIMBAL

ZERO-X | **PRO**

ZXMP-D500

ZERO-X IS A PROUD DRONE SAFETY ADVOCATE



Test your knowledge at knowyourdrone.gov.au

Be aware of local legislations and read the instructions carefully before using your drone. Keep yourself and others safe when flying your Zero-X drone. Always fly your drone within visual line-of-sight and only fly one drone at a time. Do not allow your view of the drone to be impaired eg: in rain, wind, snow, fog or low light. When flying your drone, please keep in mind the safety and privacy of others.

Do not get your drone wet, dusty or sandy. Do not touch your drone while it is powered on and when the rotor blades are turning.

For replacement parts batteries, blades, and accessories please visit your nearest Zero-X retailer or visit www.zero-x.com.au | www.zero-x.co.nz

CONTENTS

1.0 WELCOME	4
1.1 BEFORE YOU GET UP IN THE AIR	4
1.2 GENERAL SAFETY	4
2.0 PRODUCT CONTENTS	5
2.1 PRODUCT OVERVIEW	6
2.2 CONTROLLER OVERVIEW	6
3.0 BATTERY SAFETY	7
4.0 SETTING UP YOUR STRATUS DRONE	9
4.1 INSTALLING THE BATTERY	9
4.2 INSTALLING A MICRO SD CARD	9
4.3 REMOVING A MICRO SD CARD	9
4.4 FOLDING/UNFOLDING THE DRONE	10
4.5 REMOTE CONTROL	10
5.0 REMOTE CONTROL FUNCTIONS	11
5.1 SWITCHING BETWEEN FLIGHT MODES	11
5.2 LCD SCREEN DISPLAY	11
5.3 PAIRING YOUR DRONE AND REMOTE CONTROL	11
5.4 PHOTO/VIDEO CONTROLS	12
5.5 ONE-KEY TAKE OFF & LANDING	12
5.6 ONE-KEY RETURN TO HOME BUTTON	12
5.7 DRONE LOW BATTERY WARNING	13
5.8 REMOTE CONTROL LOW BATTERY WARNING	13
5.9 SIGNAL STRENGTH INDICATOR	14
5.10 LOCK / UNLOCK THE DRONE	14
6.0 THROTTLE CONTROL STICK MODE	15
6.1 THROTTLE MODE SWITCH	15
6.2 HOW TO CHANGE THROTTLE MODE	15
7.0 SETTING UP THE MOBILE PHONE HOLDER	16
8.0 DOWNLOADING THE APP TO YOUR MOBILE PHONE	16
8.1 WHERE TO DOWNLOAD	16
8.2 ZERO-X APP	16
8.3 CONNECTING YOUR SMARTPHONE TO THE DRONE'S WIFI	17
8.4 SAVING PHOTOS AND VIDEOS	17
9.0 PRE-FLIGHT CHECKLIST	17

- 10.0 STATUS INDICATOR LIGHTS..... 18**
- 11.0 FLIGHT SAFETY..... 19**
- 12.0 UNDERSTANDING KEY CONTROLS..... 19**
 - 12.1 AUTO RETRUN HOME..... 19
 - 12.2 RETURN HOME (GPS MODE ENABLED)..... 19
 - 12.2.1 SMART RETURN TO HOME..... 20
 - 12.2.2 LOW BATTERY RETURN TO HOME..... 20
 - 12.2.3 FAILSAFE - OUT OF CONNECTION RETURN TO HOME..... 21
 - 12.3 CAMERA ANGLE ADJUSTMENT..... 21
 - 12.4 OPTICAL FLOW..... 22
- 13.0 START FLYING YOUR DRONE..... 22**
 - 13.1 GYROSCOPE CALIBRATION..... 22
 - 13.2 GEOMAGNETIC CALIBRATING YOUR DRONE..... 23
 - 13.3 OPTIMAL TRANSMISSION ZONE..... 24
 - 13.4 UNLOCKING THE DRONE..... 24
 - 13.5 LOCKING THE DRONE..... 24
 - 13.6 SETTING A HOME POINT..... 25
 - 13.7 BASIC FLIGHT CONTROLS..... 25
- 14.0 BEGINNER MODE..... 26**
- 15.0 SPEED MODE..... 27**
- 16.0 HEADLESS MODE..... 27**
- 17.0 FLY AROUND-ME MODE..... 27**
- 18.0 FOLLOW ME MODE (GPS MODE ENABLED)..... 28**
- 19.0 WAY POINT FLIGHT (GPS MODE ENABLED)..... 28**
 - 19.1 VISION POSITIONING SYSTEM..... 30
 - 19.2 PHOTO MODE..... 30
 - 19.3 VIDEO MODE..... 30
 - 19.4 VIEWING PHOTOS AND VIDEOS..... 30
- 20.0 ACTIVATING SEARCH FUNCTION FOR A LOST DRONE..... 31**
- 21.0 DRONE MAINTENANCE..... 31**
- 22.0 REPLACING ROTOR BLADES..... 32**
- 23.0 REPLACEMENT PARTS..... 33**
- 24.0 WARRANTY TERMS & CONDITIONS..... 34**
- 25.0 NOTES..... 37**

1.0 WELCOME

Thank You for a purchasing a Zero-X Drone. The Zero-X range has been specifically designed to provide the intermediate to advanced user with a great flight experience. Please take the time to read the following safety warnings and operating instructions carefully. In this document, the Zero-X Pro ZXMP-D500 Stratus Drone will be referred to as the "Drone".

1.1 BEFORE YOU GET UP IN THE AIR

Before you familiarise yourself with your Drone, we ask that you read **"Battery Safety" on page 7** before you start charging your Drone's battery.

WARNING: PLEASE DO NOT MOVE THE CAMERA MANUALLY AS IT CAN DAMAGE THE GIMBAL AND CAMERA.

1.2 GENERAL SAFETY

Please familiarise yourself with your local legislation regarding your Drone usage before you begin using your Drone. Included in the package contents of your Drone are the Australian CASA guidelines. Please familiarise yourself with your local Drone legislation and make sure you are using your Drone within the parameters of these laws. Zero-X takes no responsibility for the operation of this product.

DO NOT fly your Drone any closer than 30 metres from people, animals or buildings. Check to make sure you are no closer than 5.5 kilometres from any airfields or airports. For more information on CASA's Australian legislation visit: <http://www.casa.gov.au/>

- You must not fly your Drone higher than 120 metres (400 ft) above the ground.
- You must only fly during the day and keep your Drone within visual line-of sight.
- For information outside Australia please visit the website of your local aviation authority.
- **DO NOT** attempt to modify the Drone or any of its components in any way, doing so will void your warranty and may affect the operation of the Drone.
- **DO NOT** use the Drone in any conditions that could affect, damage or impair your view including wet, dusty or sandy conditions. These elements will damage the components of your Drone.
- Please **DO NOT** attempt to touch the Drone when the Remote Control is powered on, or if the rotor blades are turning.
- When flying your Drone, please keep in mind the privacy of others.

2.0 PRODUCT CONTENTS

1. Stratus Drone
2. Remote Control
3. Rotor Blades x 4
4. USB AC Wall Charger
5. USB Charging Cable
6. User Manual
7. Small Screw Driver
8. Screws
9. Quickstart Guide
10. Carry Case

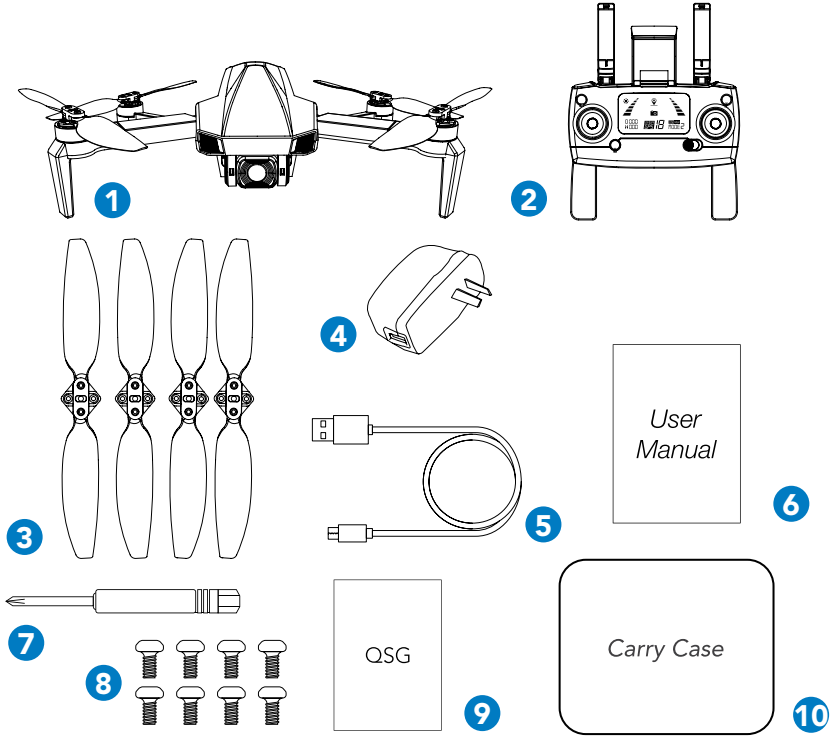

2.1 PRODUCT OVERVIEW

1. Brushless Motor
2. Landing Gear
3. Blades
4. Camera

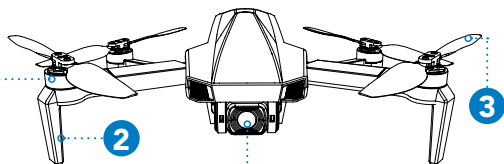

5. Optical Flow System
6. Status Indicator Light
7. Power Switch

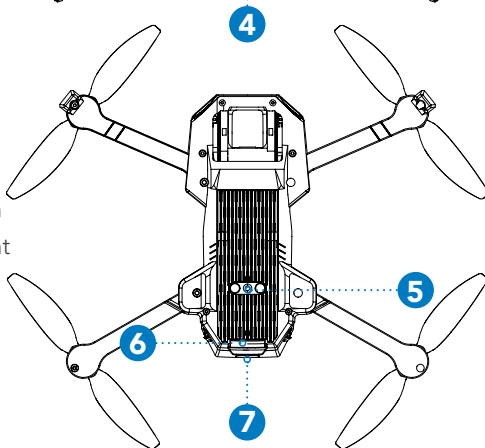

2.2 CONTROLLER OVERVIEW

1. Photo/Video
2. Left Thumb Stick (Yaw left/Right)
3. Lock/Unlock Button
4. Mobile Phone Holder
5. Return to Home Button
6. Right Thumb Stick (Forward/Backward, Left/Right)
7. Power On/Off
8. LCD Screen
9. Take Off/Landing Button
10. Camera Up/Down
11. High/Low Speed (Long Press)
12. GPS Switch

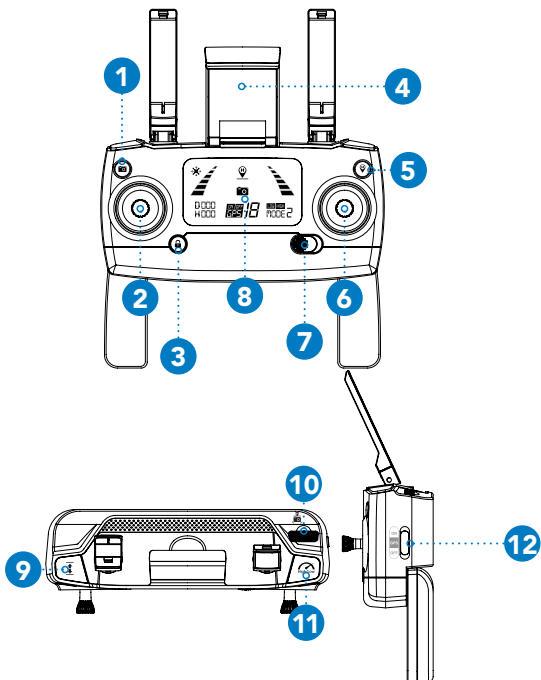

IMPORTANT INFORMATION - PLEASE READ BEFORE USE

3.0 BATTERY SAFETY

When handled incorrectly, Lithium polymer batteries can be dangerous and can potentially harm and do damage to persons or property. Zero-X does not accept any liability for damage to persons or property if the battery is not correctly charged, stored or protected.

- Always unwind all cables before charging.
- **DO NOT** over charge the battery. Once the charging process is completed, remove the battery from the charger as soon as possible.
- Only use the included or replacement Stratus Drone chargers and batteries.
- You must charge the Lithium polymer battery in a safe area away from flammable materials.
- The battery is only to be charged under adult supervision, do not leave charging batteries unattended. You should always remain in constant observation to monitor the charging process and react immediately to any potential problems that may occur.
- **DO NOT** charge the battery in temperatures hotter than 40°C or colder than 0°C.
- **DO NOT** cover the batteries when charging or leave them in direct sunlight.
- After each flight & or crash, please check battery for any damage or swelling.
- If the battery is damaged, leaking, making noise, punctured or malformed in any way **DO NOT** attempt to use it. Please dispose of the battery immediately and safely in the correct manner.
- **DO NOT** bend, puncture, crush or scratch the Drone's battery. **DO NOT** store batteries in your pockets, on your person or in extreme temperatures.
- After flying/discharging the battery you must allow it to cool to ambient/room temperature before recharging.
- If at any time during the charge or discharge process the battery begins to balloon or swell, discontinue charging or discharging immediately. Quickly and safely disconnect the battery, then place it in a safe, open area away from flammable materials to observe it for at least 15 minutes. **Continuing to charge or discharge a battery that has begun to balloon or swell can result in a fire.** A battery that has ballooned or swollen even a small amount must be removed from service completely.
- Never plug in a battery and leave it to charge unattended overnight.
- Non-compliance with the above warnings may result in the failure of the battery.

PLEASE NOTE: YOUR ZERO-X DRONE COMES WITH A CERTIFIED ZERO-X USB AC CHARGING ADAPTER AND CABLE FOR 240V CHARGING OF YOUR DRONE BATTERY. USE OF A NON ZERO-X CERTIFIED USB AC CHARGING ADAPTER AND CABLE WILL VOID YOUR WARRANTY AND MAY DAMAGE BOTH YOUR BATTERY AND DRONE.

- Press the buckle and pull out the battery from the your Drone. Connect the Drone battery to the charging cable. The light on the battery will blink green during charging.
- The light on the battery will turn solid blue once charging is complete. Once the battery is in a low power state, the blue power indicator will start flashing. At this time, please fly the Drone back immediately and charge the battery to avoid unnecessarily losing your Drone.
- To keep the battery life as long as possible avoid removing the battery from the charging cable before charging is complete. If you have just finished flying your Drone, please allow the battery to cool down for at least 30 minutes before recharging.
- The Drone battery may take up to 5 hours to charge. If the battery has been on charge for any longer than 6 hours and the indicator on the charging cable is not showing that the battery is charged, please remove the battery from the charger.
- When the Drone battery has finished charging it is advised that the battery is removed from the charger as soon as possible. Overcharging will damage the battery and affect the flight time.

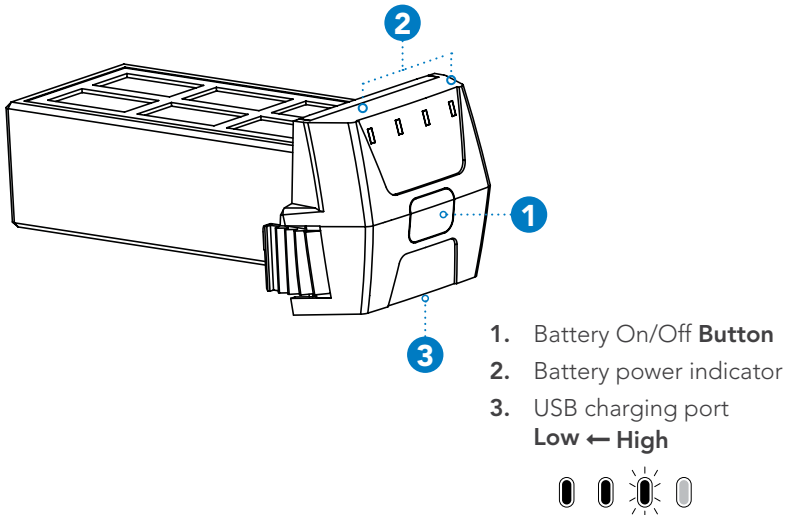

4.0 SETTING UP YOUR STRATUS DRONE

4.1 INSTALLING THE BATTERY

1. Ensure that the battery is fully charged.
2. Insert the battery into the middle of the Drone in the correct orientation.
3. Slide the battery all the way down until it securely slots into place.

NOTE:

- Do not force the battery, if the battery is not fitting into position, please check that you have the battery in the correct orientation.

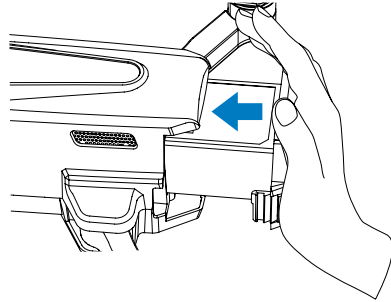

4.2 INSTALLING A MICRO SD CARD

The Micro SD Card slot is on the left bottom side of the Drone. To insert the Micro SD card, please follow these steps:

1. Turn the Drone upside down and then, with the Micro SD Card copper contacts facing down and toward the Drone, slot the Micro SD Card into the slot on the left side of the Drone. Gently press the card in until you hear the click into place.

NOTE:

- Please format your SD card before use. To format correctly, insert the Micro SD Card in your PC and follow the prompts.

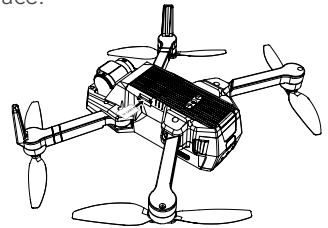
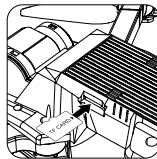

4.3 REMOVING A MICRO SD CARD

To remove your Micro SD Card, follow the instructions below.

1. Press the Micro SD Card into the unit, until a click is heard and the card releases.
2. The card will now release, and the Micro SD Card will now be removable. (Micro SD Card not included).

NOTE:

- We recommend you use a Micro SD Card, memory Class 10 or above, with a minimum 64GB & maximum 128GB capacity.
- If used without a Micro SD Card, videos will be stored directly on your mobile phone. Recordings on your smartphone will be descaled to save space.

4.4 FOLDING/UNFOLDING THE DRONE

The Drone can be folded for easy storage and transport. It's arms are designed to fold out in a specific order, with the front arms folding outward first and the back arms folding outward second. To fold down, fold in the back arms first and then front arms second.

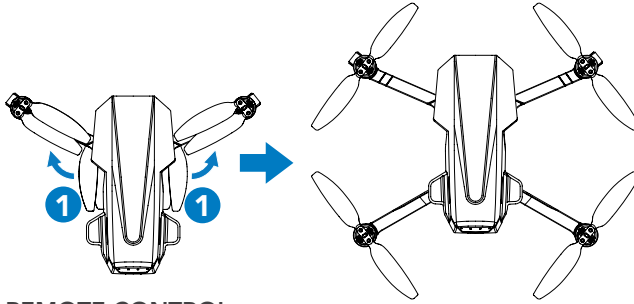

4.5 REMOTE CONTROL

The remote control is battery operated and will require two AA batteries to use. To access and open the battery door, you will need to unfold the hand sticks. Then place the two batteries in the correct positions and close the battery door. To Power On the remote control, slide the Power On **button** to the right. To Power Off, slide the **button** to the left.

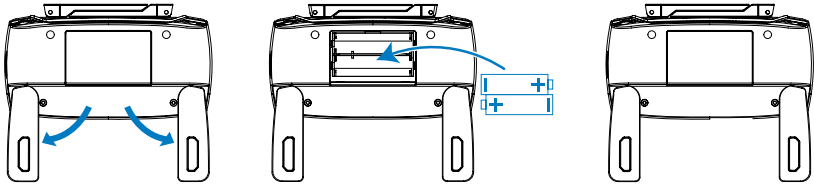

* AA Batteries are not included

NOTE:

- Insert the batteries in the correct orientation.
- **DO NOT** charge non-rechargeable batteries. The transmitter needs two charged and working AA batteries to operate.
- **DO NOT** mix old and new batteries. This may compromise the power of the remote control.
- **DO NOT** use a combination of batteries. Only use one type being either 2 x Standard (Carbon zinc batteries), 2 x alkaline batteries or 2 x rechargeable (Nickel-cadmium batteries).
- Always fully charge rechargeable batteries before using them. The remote control does not charge them during use.
- Children should handle rechargeable batteries with adult supervision.
- Always remove empty batteries from the remote control to avoid confusion for use on the next flight.
- **DO NOT** short circuit the supply terminals.

5.0 REMOTE CONTROL FUNCTIONS

5.1 SWITCHING BETWEEN FLIGHT MODES

To choose which mode to fly your Drone in, switch the **GPS button** to either the ON or OFF positions. The ON flight mode  is shown on the LCD display.

NOTE:

- GPS Mode is recommended for outdoor flying.
- Optical Flow is recommended for Indoor flying. Indoor flying may have weak GPS Signal which can cause damage if the drone is continued to be flown in GPS mode.

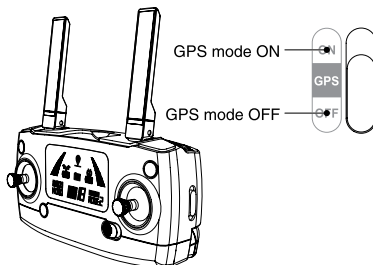

5.2 LCD SCREEN DISPLAY

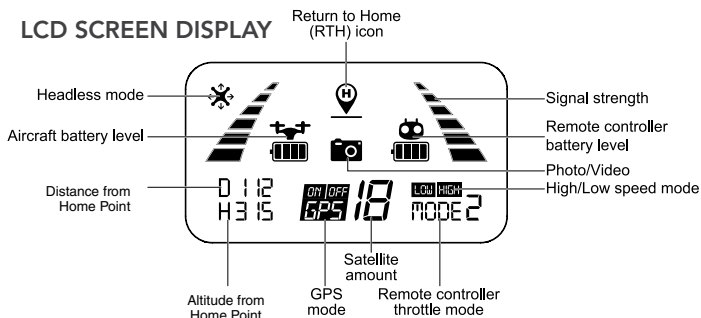

5.3 PAIRING YOUR DRONE AND REMOTE CONTROL

1. Hold down the **lock button** and swipe the Power ON **button** to the right, to turn on the remote control.
2. Ensure that the battery is connected correctly to the Drone. Power ON your Drone by pressing down the **button** on the top of the battery for 3 seconds. The Drone will make a sound and the 4 lights will come on in a sequence. The rear middle light of the drone will be turned on. The Drone will then beep two times and the lights will switch to flashing alternatively yellow.
3. The remote control will begin to pair with the Drone automatically. Once a successful connection has been made the remote control will beep two times. The Drone's indicator lights will change to alternatively flashing yellow. The signal connection bars on the remote LCD screen will now show . The remote control will show both the battery level of the Drone and the remote control on the LCD screen. Please charge your Drone if the battery level is running low.

NOTE:

- To avoid any signal errors when connecting the Drone to the controller, ensure you turn on the remote control first and then the Drone.

5.4 PHOTO/VIDEO CONTROLS

To take a photo with your Drone, short press the **📷 button** on the remote control. The same icon on the LCD screen will flash once, confirming a photo has been taken.

To record a video with your Drone, long press the **📷 button** on the remote control. The same icon on the LCD screen will slowly flash continuously, indicating that the Drone is recording. To stop recording long press the **📷 button** again.

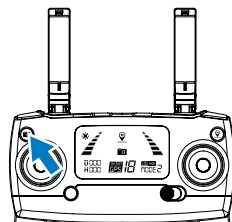

NOTE:

- To take 4K photos and videos you must have a Micro SD Card inserted into the Drone. If the Micro SD Card is not formatted correctly the Drone will not be able to capture any images or footage. Please format the Micro SD card in your PC prior to use in the Drone.
- The quality of photos and videos recorded on your smartphone will be de-scaled to save space.

5.5 ONE-KEY TAKE OFF & LANDING

When you have unlocked your Drone, short press the **⬆️ button** on the remote control (as shown in the picture below). The Drone will automatically take off and hover 1.5m off the ground.

To automatically land your Drone during a flight, short press the **⬆️ button** on the remote control (as shown in the picture below). The Drone will automatically land on the ground safely. During descent, while in one key landing mode, if you toggle any of the joysticks it will cause the Drone to discontinue this mode.

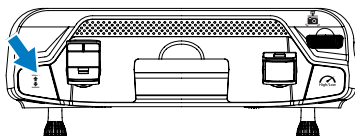



5.6 ONE-KEY RETURN TO HOME BUTTON

To activate the RETURN TO HOME MODE press the **📍 button** on the top right side of the remote control (as shown in the picture on the right). The buzzer will beep to indicate that auto return home has been activated.

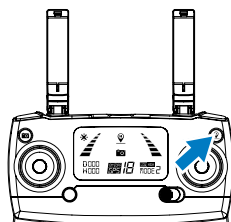
The Drone will return to the last home point. Press the **📍 button** shortly again, and the Drone will exit return home mode.



5.7 DRONE LOW BATTERY WARNING

If the rear indicator lights on the Drone are flashing red slowly, this indicates your battery level is starting to get low. The battery icon on the remote control LCD screen will be  (See Pic 1 below for reference). If your Drone is more than 100 metres away or more than 30 metres in altitude from the take off location (home point), it will return home automatically. If your Drone is flying within a 100 metre range, you can cancel the automatic return home by pressing the "" **button** on your remote control.

If the indicator light is flashing red slowly or rapidly, this indicates your battery levels are very low, and you should finish your flight. The battery icon on the remote LCD screen will be  accompanied by a steady 'beep beep' sound (See Pic 2 below for reference). If your Drone is more than 15 meters away or more than 15 meters in altitude (compared to its take off location) it will automatically land on the ground.

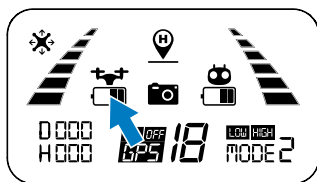

Pic. 1

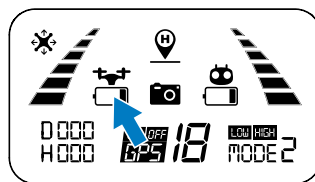

Pic. 2

5.8 REMOTE CONTROL LOW BATTERY WARNING

When the batteries in your remote control are running very low, a  icon will appear on the remote LCD screen accompanied with a 'beep beep' sound. Now is the time to change batteries to new AA or fully charged (rechargeable) batteries.

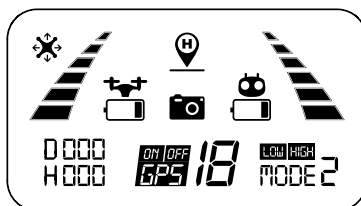



NOTE:

- Remote control batteries must be the same type. Please do not mix battery types.

5.9 SIGNAL STRENGTH INDICATOR

On the remote LCD screen you will see identical bars on the left and right, these indicate the strength of the connection between your remote control and the Drone. The stronger the signal is, the more bars will show.

- If the signal is strong the bars will appear .
- If the signal is connecting, the bars will appear,  leveling up in a constant rotation pattern.
- If the signal is weak, 2 or less bars will appear .

There are two reasons as to why the connection may be weak, and will show 2 bars or less:

1. There is too much distance between the Drone and the remote control, causing the signal to weaken.
2. The battery in the Drone is removed after connecting to the remote control - terminating the connection.

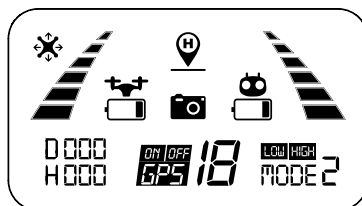

5.10 LOCK / UNLOCK THE DRONE

In case of an emergency or after your Drone has landed, you can instantly suspend the Drone's flying capabilities and lock the motor.

There are two ways to lock the motors:

1. After you have successfully landed the Drone, pull the throttle down to the bottom and hold for 3 seconds. This will stop the motors and lock the Drone. (Refer to section "**6.1 THROTTLE MODE SWITCH**" on page 15)
2. If there is no activity for longer than **15 seconds** the Drone will automatically lock.

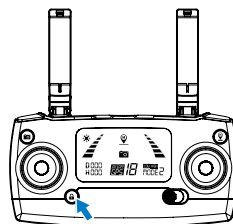

To unlock the Drone, short press the **lock button**, this will activate the motors.

NOTE:

- You can use the **lock button** in case of an emergency to lock the Drone's motors. Hold the **lock button** for 3 seconds to activate the lock. Please do not use this in normal flight, only in emergency situations.
- Please ensure there is a safe distance between you and the Drone before locking the motors.
- The emergency stop operation will only activate when the Drone is within 15 metres (distance and altitude) from the take off location (home point), and only when the GPS function is active with a strong Drone signal strength (more than 7 satellites).

CAUTION: Please be careful as locking the Drone motors during flight will cause the Drone to drop immediately which may result in injury and damage to your Drone.

6.0 THROTTLE CONTROL STICK MODE

6.1 THROTTLE MODE SWITCH

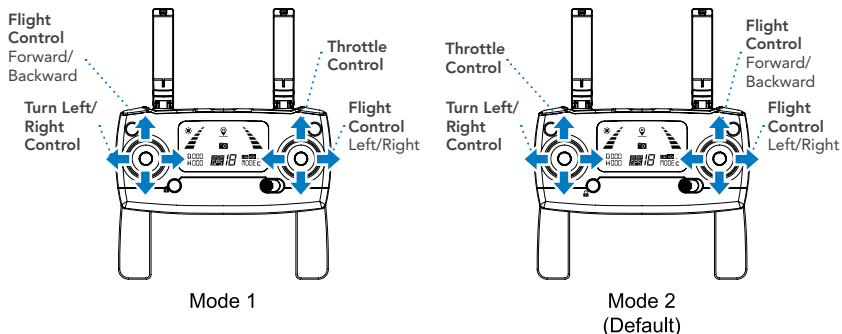

In **MODE 1** the right control stick controls the throttle. In **MODE 2** the left control stick controls the throttle. The factory settings in the remote control are set to Mode 2 (Default).

6.2 HOW TO CHANGE THROTTLE MODE

1. Hold down the **lock button** and swipe the Power ON **button** to the right to turn on the remote control. The signal bars will go into signal connection mode. (See Pic 1 below for reference).
2. Now hold down the **mode button** for 3 seconds (See Pic 2 below for reference). The remote control will beep when the throttle mode changes. To revert to original throttle mode hold down the **mode button** again for 3 seconds, the remote control will beep again to confirm the change.

The mode number you are currently on will be displayed on the remote LCD screen at the bottom right.

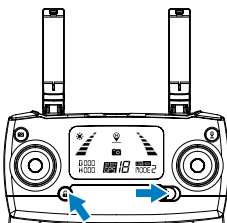

Pic 1

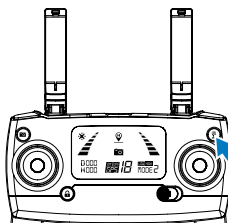

Pic 2

NOTE:

- In order to change the throttle mode the signal must be in signal connection mode. If it is not in this mode it will not allow you to change the throttle mode.

7.0 SETTING UP THE MOBILE PHONE HOLDER

1. Pull out the mobile phone holder, it will click in place when it has been completely pulled out. This can be found on the top of the remote control between the two antennas.
2. Tilt the phone holder towards you about 30° to click in place. Note the holder will only tilt towards you if it has been fully extended.
3. Tilt the support board towards you. This will sit against the body of the remote control. (See Pic 3 below for reference).
4. Pull up the top of the phone holder to adjust in accordance to the size of your phone. You can now place your phone into the holder and it will securely clamp and hold your phone in place.

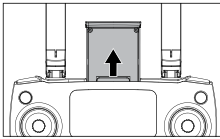

Pic. 1

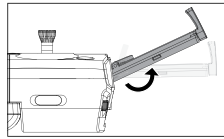

Pic. 2

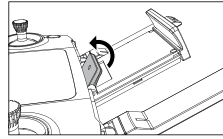

Pic. 3

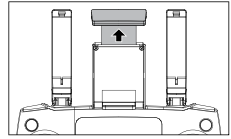

Pic. 4

8.0 DOWNLOADING THE APP TO YOUR MOBILE PHONE

8.1 WHERE TO DOWNLOAD

For iPhones - go to the Apple App Store and search for the Zero-X Evolved 4K App.

For Android phones - go to the Google Play Store and search for the Zero-X Evolved 4K app.

OR scan the QR code to download the App.

The Zero-X Evolved 4K App requires iOS 11.0 and above on iPhone or Android 7.0 device to run.



8.2 ZERO-X APP



The Drone has a built in WIFI connection which is used to wirelessly connect your smartphone to your Drone. This allows you to view the Drone camera live view, trigger recording, control and fly your Drone.

To connect your smartphone to the Drone please follow the instructions below.

Go to the Google Play store if you are using an Android Smartphone, or the Apple Store if you are using an iPhone and search for the App named "ZXP-EVD4K or Zero-X Evolved 4K", once located please download and install the App.

Connect the App, then go into the WIFI settings on your smartphone and select the connection named ZXMP-D500_XXXX (XXXX will be your unique Drone number). Once connected, open the ZXP-EVD4K App on your smartphone.

8.3 CONNECTING YOUR SMARTPHONE TO THE DRONE'S WIFI

1. Go to your mobile phones settings menu and enter the WiFi settings.
2. Turn on your Drone.
3. If your smartphone WiFi is turned off, turn it on and search for ZXMP-D500_XXXXXXX in the available networks. Select ZXMP-D500_XXXXXXX, once the connection is successful a  icon will appear next to it.

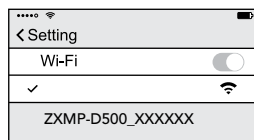

8.4 SAVING PHOTOS AND VIDEOS

- If your Drone does not have a Micro SD card inserted, all photos and videos will be saved with the App onto your smartphone, however, the image quality will not be as sharp on your connected mobile device compared to images and videos that are saved onto the Micro SD card.
- If you have the Micro SD card inserted, all photos and videos will be saved to it.
- You can also download the images that have been saved onto the micro SD card onto your Zero-X Evolved 4K app.

NOTE:

- Only mobile phones that support the 5G WiFi (802.11.ac) can make FPV connections.

9.0 PRE-FLIGHT CHECKLIST

- Check your Drone, controller and device are all fully charged.
- All blades are installed correctly.
- All arms are fully unfolded.
- Camera lens is clean, free of dirt and dust.
- The Zero-X Pro Evolved 4K App is downloaded and installed on your device.
- All parts used are genuine Zero-X Pro ZXMP-D500 products. Using other parts that are not made specifically for the Drone can be unsafe or cause the Drone to fail.

10.0 STATUS INDICATOR LIGHTS

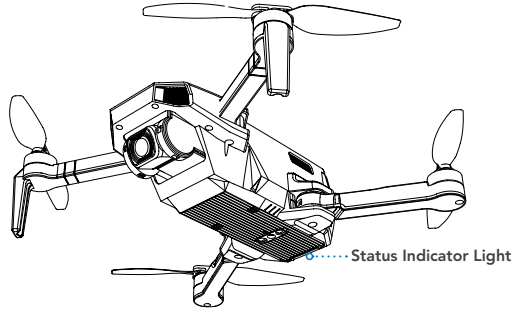

Please see the table below for reference when your Drone status indicator lights are activated and what they mean.

LED Status	Indicates
The indicator light flashes Yellow rapidly	Drone is disconnected from the controller
The indicator light is solid Yellow	No GPS Signal. Drone not in GPS mode
The indicator light is solid Green	Good GPS Signal. Drone is preparing for GPS mode
The indicator light is Green and flashing rapidly	Drone is in gyroscope calibration mode
The indicator light is Yellow and flashing slowly	Drone is in compass horizontal calibration mode
The indicator light is Green and flashing slowly	Drone is in compass vertical calibration mode
The indicator light is Red and flashing slowly	Drone battery is getting low, only 1/6 of charge left
The indicator light is Red and flashing rapidly	Drone battery is getting low , only 1/8 of charge left
The indicator light flashes Red once, stops for 1.5 secs & flashes again	Error with the gyroscope
The indicator light flashes Red twice, stops for 1.5 secs & flashes again	Error with the barometer
The indicator light flashes Red three times, stops for 1.5 secs & flashes again	Error with the compass
The indicator light flashes Red four times, stops for 1.5 secs & flashes again	Error with the GPS module

11.0 FLIGHT SAFETY

Before flying your Drone please make sure the area is safe and adheres to Drone flying regulations.

CASA restrictions regarding flying Drones require them to be no less than 5.5 kms from any airport or airfield while flying. Drones should also not be flown higher than 120 metres above the ground, over populated areas or any closer than 30 metres from vehicles, people or animals.

Please check your surroundings before taking off, making sure there are no obstacles or dangers in the area, including overhead power lines and bodies of water. If there are hazards in your intended area of flight, find an alternative location. Please note, tall structures and large metal structures may affect the accuracy of the inbuilt GPS and compass.

Be sure to fly your Drone in appropriate weather conditions. Do not fly your Drone in very high temperatures, snow, extremely strong winds, rain or fog. Please also note, this Drone's GPS system wont work in polar regions.

For your safety, the default control of the Drone is set to Beginner where the flight parameters are fixed. To change the parameters, please deselect the Beginner mode in the App's Flight Settings. To download the App please refer to **page 16**.

12.0 UNDERSTANDING KEY CONTROLS

Please read through the instructions below before launching the Drone.

WARNING: DO NOT PRESS ANY KEY WHEN RETURN TO HOME IS INITIATED AS IT MAY CAUSE THE DRONE TO FLY AWAY.

12.1 AUTO RETRUN HOME

The Auto Return to Home function is very important. It is vital that all Drone users understand how to use it.



7

When taking-off, or in flight and when the GPS signal reaches more than 7 for the first time, the current position of the Drone will be recorded as the **Home Point**.

12.2 RETURN HOME (GPS MODE ENABLED)







The **Return Home** button will initiate the automatic landing sequence. Please make sure there are no obstructions, people or animals under the Drone when this is selected.

If the Drone's flying altitude is less than 15 meters from ground level and the **Return Home** button is pressed, the Drone will gain altitude first and then return home. If the Drone is not connected with the App, please press the **Return Home** button on the controller for the Drone to safely land at the starting point. There are 3 different types of Return to Home scenarios: **Smart Return to Home**, **Low Battery Return to Home** and **Failsafe Return to Home**.

WARNING: DO NOT PRESS ANY KEY WHEN RETURN TO HOME IS INITIATED AS IT MAY CAUSE THE DRONE TO FLY AWAY.

12.2.1 SMART RETURN TO HOME

Press the  button on your remote control or click the  icon on your App and follow the instructions on screen, the remote control will start beeping. Your Drone will return to the take off point if the  button is pressed on the remote control, this will cause the remote control to start beeping. To stop RETURN TO HOME FUNCTION, please press the  button again.

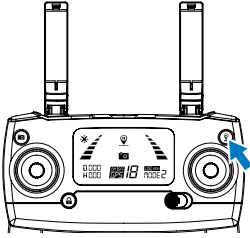

Pic. 1





Pic. 2

WARNING: DO NOT PRESS ANY KEY WHEN RETURN TO HOME IS INITIATED AS IT MAY CAUSE THE DRONE TO FLY AWAY.

12.2.2 LOW BATTERY RETURN TO HOME

If the Drone's battery level is low, a 'failsafe' mechanism is triggered. When your Drone's battery is low, we recommend quickly landing it or using the Return To Home function.

There are two warnings for low battery levels:

1. When the rear indicator light is flashing red slowly, you will notice the battery icon displayed as  on the remote LCD screen. This will cause the remote control to beep. If your Drone is more than 100 metres away or more than 30 metres away in altitude from the take off location Home Point, it will return home automatically. If it is within the 100 metre distance you can terminate the Return to Home by simply pressing the  button on your remote control.
2. When the rear indicator light is flashing red slowly, but the battery icon is displayed as  on the remote LCD screen, a steady beep sound will come from the remote control. If your Drone is more than 15 metres away it will Return to Home automatically. If it is within the 15 metre distance the Drone will automatically land and lock the motors.

WARNING: DO NOT PRESS ANY KEY WHEN RETURN TO HOME IS INITIATED AS IT MAY CAUSE THE DRONE TO FLY AWAY.

12.2.3 FAILSAFE - OUT OF CONNECTION RETURN TO HOME

If the GPS control signal is continuously interrupted for longer than 6 seconds and the App controls are turned off, the Drone's internal flight control system will take over. In doing this, it will force the Drone to the Home Point. If the GPS signals are restored during the Return to Home, the Drone will continue its return, to cancel this and regain control press the  button on your remote control.

NOTE:

- The Drone is not equipped to avoid obstacles.
- When the Drone is in automatic Low Battery Return to Home mode you cannot cancel this unless stated above. To continue flying you will need to charge the battery or insert a spare charged battery. (Spare batteries available separately.)

WARNING: DO NOT PRESS ANY KEY WHEN RETURN TO HOME IS INITIATED AS IT MAY CAUSE THE DRONE TO FLY AWAY.

12.3 CAMERA ANGLE ADJUSTMENT

You can adjust the angle of your camera within a 90° range by using the gimbal trimmer. Adjusting the camera angle can help in obtaining a better aerial experience. To tilt the camera upwards, scroll the gimbal trimmer to the left (in the direction of 'A' in the diagram). To tilt the camera downwards, scroll the gimbal trimmer to the right (in the direction of 'B' in the diagram).

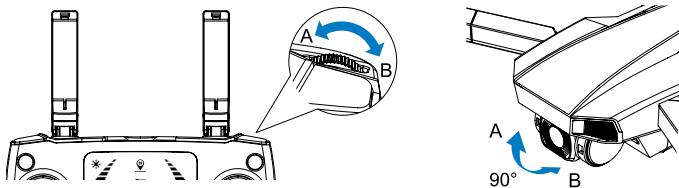

WARNING: PLEASE DO NOT MANUALLY MOVE THE CAMERA AS IT WILL DAMAGE THE GIMBAL AND CAMERA.

12.4 OPTICAL FLOW

The optical flow system consists of optical flow lens modules. This system will obtain the Drone's position through optical images, which will ensure safe flights and accurate positioning. See below for reference, so you can see where the optical flow camera is located on your Drone.

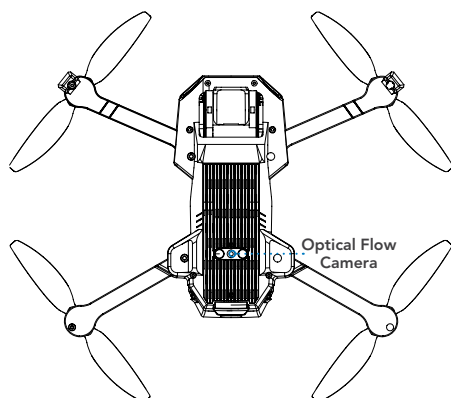

NOTE:

- Optical flow mode is good to fly indoors or outdoors with low GPS coverage

The measurement of accuracy whilst in the optical flow function can be affected if:

- You're flying fast at low altitude (below 0.5 metres) - the optical flow system may not be able to locate the Drone.
- Flying over monochrome surfaces (such as pure black, pure white, red green), surfaces with strong reflections, water or transparent surfaces

These factors can cause optical flow failure, which may cause the Drone to go into fixed altitude mode.

13.0 START FLYING YOUR DRONE

13.1 GYROSCOPE CALIBRATION

Put the Drone on flat ground and pull both thumb sticks to the bottom left corner together at the same time.

(See picture for reference).

The indicator light will start **flashing green**, rapidly which means calibration has started.

It will turn to **solid green** which confirms the Gyroscope Calibration is complete.

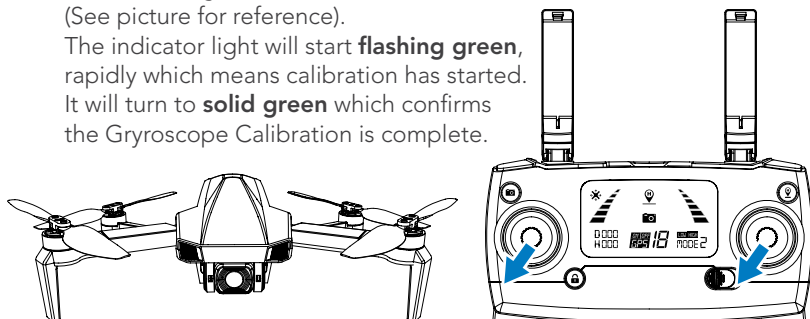

13.2 GEOMAGNETIC CALIBRATING YOUR DRONE

To enter into calibration mode, you must unlock the Drone first.

To do this, pull both thumb sticks to the bottom right corner together at the same time. (See picture for your reference).

There are two steps to calibrate your Drone successfully: Horizontal calibration & Vertical calibration.

NOTE:

- It is recommended to calibrate your Drone before each flight.

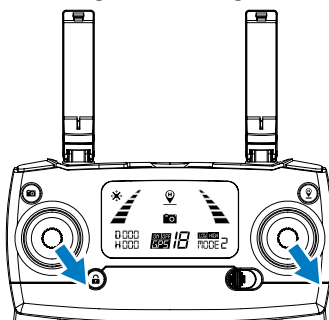

STEP 1: HORIZONTAL CALIBRATION

Turn on the Drone and remote and pair them if they are not paired already, the indicator light will turn yellow and start flashing. Hold the Drone horizontally and rotate it 360° by the centre at least 3 times. When the horizontal calibration has completed the lights will change to flashing **green** slowly.

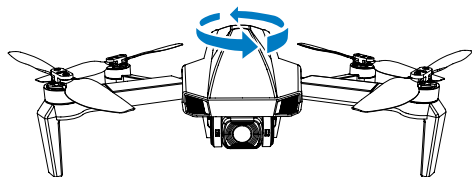

STEP 2: VERTICAL CALIBRATION

Hold the Drone vertically with the camera facing up and rotate it 360° by the centre at least 3 times. Be sure to keep the camera always facing up, otherwise calibration will not work. When vertical calibration is completed and successful the indicator light will turn to **yellow / green**.

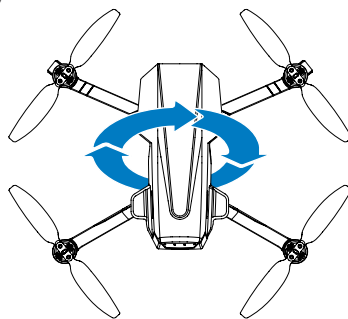

NOTE:

- Do not calibrate the Drone in an area with strong magnetic fields, parking lots or construction sites with underground reinforcement.
- Do not carry any magnetic objects or materials (such as keys or mobile phones) when you are calibrating your Drone.
- Keep away from large metal objects during the calibration process.
- It is recommended not to wear smart watches while flying your Drone as it may interfere with the GPS signal.

13.3 OPTIMAL TRANSMISSION ZONE

For a great flight experience, make sure that your Drone is flying in front of your remote control with no obstacles in between them.

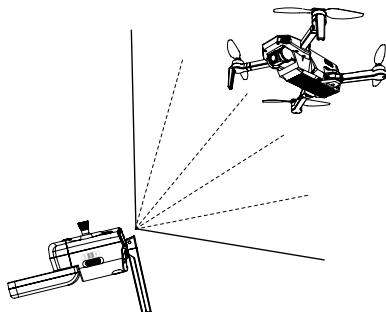

NOTE FOR INDOOR FLYING:

- When flying indoors, please turn off the "GPS switch" of the remote control to avoid the Drone getting out of control (this could be due to the weak GPS signal indoors).
- The Optical Flow positioning system is typically activated and useful for indoor environments when the GPS signal is weak or not available. The Optical Flow positioning system works best when the Drone is less than 3 meters from ground level, as the Drone has to continuously scan the ground. Please refer to the "**12.4 OPTICAL FLOW**" on page 22.
- You can connect to WIFI at this time to view real time video. Please refer to "**8.3 CONNECTING YOUR SMARTPHONE TO THE DRONE's WIFI**" on page 17 on how to connect to WIFI.

13.4 UNLOCKING THE DRONE

Please ensure the Drone is kept on the ground with a safe distance between you and the Drone before take off.

Press the **lock button** on the controller. The motor will start and the Drone is now unlocked and ready for take off. The Drone will now automatically unlock if there is no operation detected for **15 seconds**.

13.5 LOCKING THE DRONE

METHOD 1: After the Drone has landed successfully, press the throttle stick on the controller down and hold for **3 seconds**. The Motors will stop rotating and the Drone will be locked. (Refer to "**6.0 THROTTLE CONTROL STICK MODE**" on page 15)

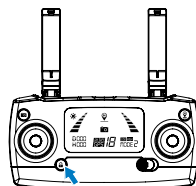

METHOD 2: The Drone will automatically lock if there is no operation detected for **15 seconds** after unlocking or landing.

13.6 SETTING A HOME POINT

If the GPS signal is strong (Satellite level over 7) before take off, the take off location will automatically be saved as the Drone's Home Location. The strength of the GPS signal is shown on the remote LCD screen at the bottom middle. You will see the strength indicated as **7** on the remote control. The Drone's indicator lights will turn solid green when the home point is successfully recorded.

13.7 BASIC FLIGHT CONTROLS

UP AND DOWN

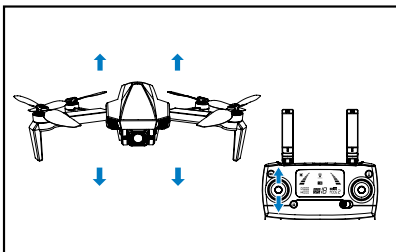

Push the left control stick up to gain altitude, and down to descend.

FORWARD AND BACKWARDS

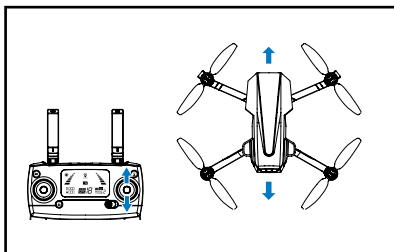

Push the right control stick up to go forward, and down to go backwards.

ROTATION

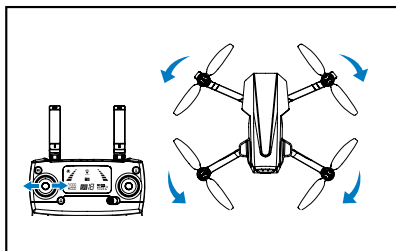

Push the left control stick left to turn left, and right to turn right.

LEFT/RIGHT FLIGHT

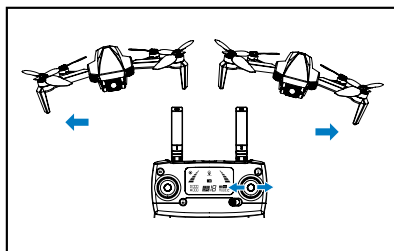

Push the right control stick left to fly left, and right to fly right.

To get smooth and stable movement in the video, push the control sticks gently.

14.0 BEGINNER MODE



- 1. Max flight altitude** - The default factory setting is OFF, therefore the Drone can reach a maximum altitude of 120 metres. To increase the maximum Drone altitude, activate the setting to ON, and move the setting slider in order to set the desired altitude. (between 15m-120m).
- 2. Max flight distance** - The default factory setting is OFF, and the Drone can reach a maximum flight distance of 1000 metres. If you want to change the maximum flight distance the Drone can reach, switch the setting to ON and move the slider to set the desired distance (between 15m-200m).
- 3. Orbit radius** - The default factory setting is 5 metres. If you want to change the orbit radius move the slider to set the desired radius (between 5m - 50m).
- 4. Return to Home (RTH)** - The default factory setting is 15 metres. To change this, move the slider to set the new RTH altitude (between 15m - 50m).
- 5. Geomagnetism calibration** - If you press this icon you can replace one of the compass calibration processes, which involves using the remote control. Alternatively, if you would like to continue using the remote control method, push both control sticks to the bottom right corner (5pm direction), see the image to the right.
- 6. Gyro calibration** - If you press this icon you can replace one of the gyro calibration processes which involves using the remote control. Alternatively, if you would like to continue using the remote control method, push both the control sticks to the bottom left corner, as per image on the right.

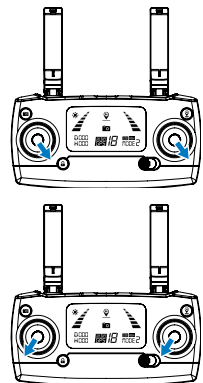

15.0 SPEED MODE

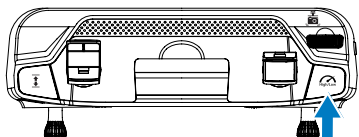

The Drone has 2 speed modes that control the acceleration and maneuverability of the Drone.

To cycle through the Speed Modes, use the Speed Button on the top right of the controller.

16.0 HEADLESS MODE

When headless mode is enabled, the Drone will move in the direction of the remote control, regardless of its orientation. This makes it easy to bring the Drone home when it is far away from you.

1. Press the  icon on the left side of the App to launch options.
2. Press the headless mode **button** on the App (shown in the diagram).
3. When headless mode is enabled, the Drone will move in the direction of the remote control, regardless of its orientation. This makes it easy to bring the Drone home when it is far away from you.



17.0 FLY AROUND-ME MODE

When activated, the Drone will undertake fixed point encircling around the desired point of interest.

1. Press the  icon on the left side of the App to launch options.
2. To activate Fly Around-Me Mode, while the Drone is in the air, aim the Drone at the desired point of interest. Press the orbit flight **button** on the App, it will set the Drone fly around radius range (within 5-50 metres).
3. Click the point of interest icon again to exit out of this mode and regain control of your Drone.

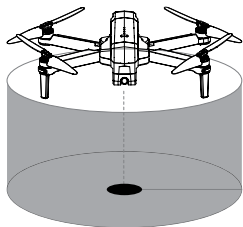

18.0 FOLLOW ME MODE (GPS MODE ENABLED)

To activate the FOLLOW-ME FUNCTION, the Drone will follow your smartphone wherever you go. Please make sure the smartphone is connected to your Drone and the Zero-X Evolved 4K App is installed and open.

1. Press the  icon on the left side of the App to launch options.
2. Fly the Drone a minimum of 5 metres and maximum 30 metres away from the user.
3. Click the follow me icon on your App.
4. Swipe right to activate the FOLLOW ME FUNCTION, the Drone will then start following the smartphone.
5. Click the follow me icon again to exit out of this mode and regain control of your Drone.

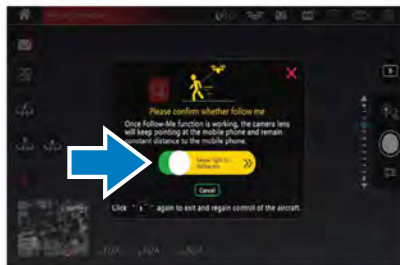

NOTE



- Follow Me mode depends on the GPS signal of your mobile device. The GPS signal can vary depending on the amount of buildings, trees, mobile towers or congestion from too many mobile phones in the vicinity.
- Please fly the Drone in open areas. The Drone is not equipped to avoid obstacles.

19.0 WAY POINT FLIGHT (GPS MODE ENABLED)

To activate WAY POINT FLIGHT, the Drone will fly according to the path which you have set. Please make sure your smartphone is connected to your Drone and the App is working. Also make sure that you have downloaded and saved the local maps onto your smartphone.

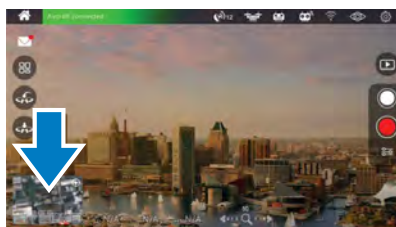
1. To enter into WAY POINT FLIGHT MODE, click the map on the bottom left corner of the App screen. After you have clicked the map, a blue circle will appear (this is your location) as well as the Drone's current position on the map.



2. Please enlarge the map and then press the  **button** on the bottom right of the App screen to choose waypoint flight mode. You can now either draw a route by pressing the  **button** or mark route points by pressing the  **button** and tapping different points on the map.

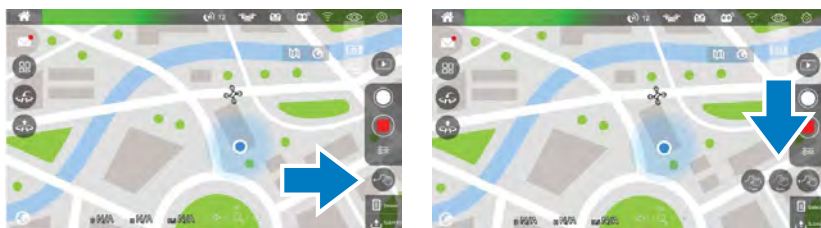

3. Once you have either drawn or marked the way point points on your map (max 18 points), click submit and swipe right to confirm your waypoint route. The Done will now fly according to the saved path.

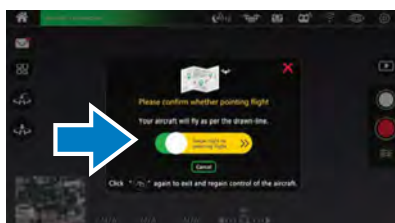
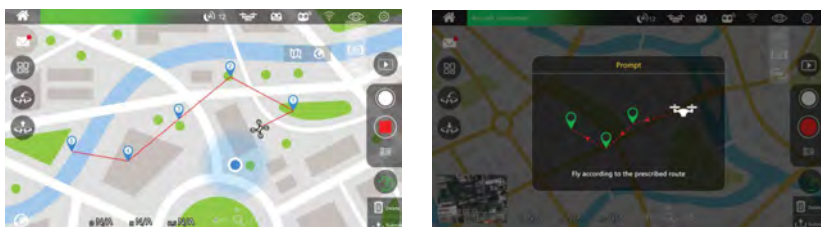

4. Press the  **button** again to exit WAY POINT FLIGHT MODE and regain flight control of the Drone.
5. To reset the flight path, press the delete **button** on the bottom right corner of the App screen.

NOTE

- Please note the Way Point Flight mode may not function correctly if there is WiFi interference.



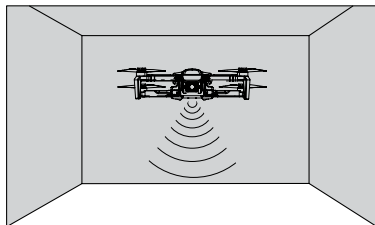

19.1 VISION POSITIONING SYSTEM

This system is typically activated and used in indoor environments when the GPS signal is weak or not available. The vision positioning system works best when the Drone is less than 3 metres from the ground.



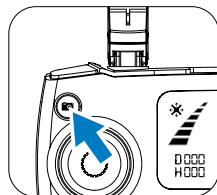

19.2 PHOTO MODE

Press the  button on the remote control or click the  icon on the App. A picture will be shown on the App indicating a photo has been taken. If the Drone is not connected with the App, please press the  button on the remote control.



19.3 VIDEO MODE

Long press the  button on the remote control. A video icon  on the remote control LCD screen will begin to flash slowly, indicating that a video is being recorded. To exit out of video mode, long press the  button again.

19.4 VIEWING PHOTOS AND VIDEOS

To view your recorded footage and videos you will need to connect the Micro SD card to your computer via either a USB Micro SD card reader or via a SD card converter if your computer has an SD card reader. (Not provided) or you can click the media gallery on your App to view your photos and videos.

NOTE:

- The quality of videos or photos saved on your smartphone are de-scaled to save space. For best resolution, ensure you have a Micro SD installed in your drone. The recommended micro SD card is Class 10 with a minimum capacity of 32GB and maximum capacity of 128GB.

20.0 ACTIVATING SEARCH FUNCTION FOR A LOST DRONE

1. Check that your mobile phone has disconnected from the Drone's WiFi.
2. Click on the "SETTINGS" **button** in the App.

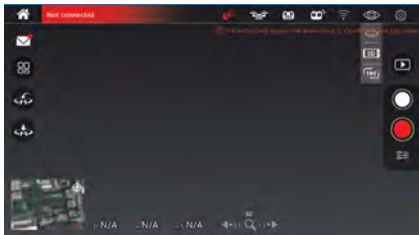

3. Click on the "FLIGHT LOG" **button** within the settings menu, and then click the "SEARCH" **button** to view the approximate flight position from when the WiFi was disconnected. You can also view the Drone's position in "FLIGHT LOG" on the map via the longitude and latitude coordinates by swiping left on the screen.

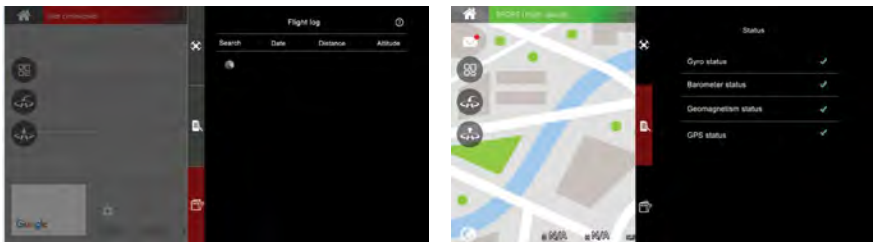

21.0 DRONE MAINTENANCE

Avoid exposing your Drone and it's accessories to dust, sand and moisture as these can damage the Drone. If the Drone is exposed to dust or sand, use a soft brush to remove any visible particles.

22.0 REPLACING ROTOR BLADES

To remove and replace the rotor blades, please follow the instructions below.

1. Unscrew the two screws on the top of the rotor blades using the supplied screwdriver. It is advised that you replace the blades one at a time to avoid losing screws or installing blades incorrectly.
2. Remove the copper plate cover from the blade clamp.
3. Replace the rotor blade with a replacement blade marking sure to match with motors.
4. Firmly press the blade into position making sure that you have aligned the motor stem with the hole in the rotor blade.
5. Lock the blade into position by putting the copper plate cover back over the screws that were removed in step 1 making sure not to over tighten.

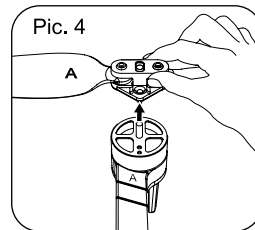
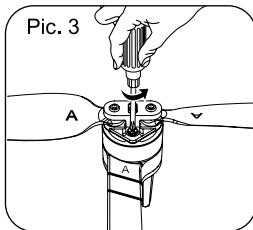
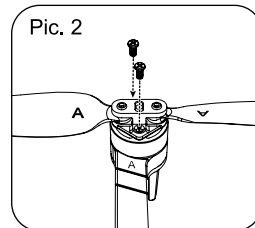
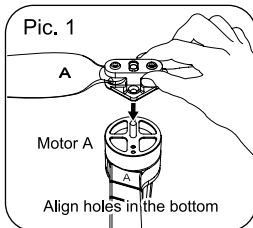
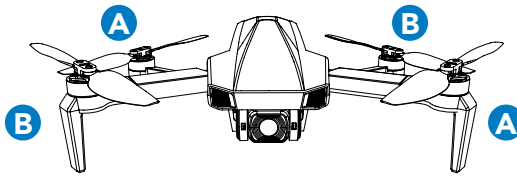

NOTE

- It is important that the correct rotor blades are installed on the correct motors as if they are installed incorrectly the Drone will not fly and you could potentially burn out the Drone's motors.
- Be aware of the sharp edges on the blades. Please handle them with care.
- Only use the Drone blades supplied with this unit. Do not mix with other blades.
- To avoid injury do not touch the blades when they are spinning.
- Only use blades that are in good condition. If they are chipped or broken replace them as this may compromise the flight.

23.0 REPLACEMENT PARTS

We understand that it's not always easy learning how to fly a Drone. In rare occurrences, a 'close call' can turn into a crash landing. Accidents happen!

To thank you for your support of Zero-X and your Drone purchase, we would like to help you build your confidence in learning how to fly your Drone by offering you 50% off your first two orders of spare parts.

Simply make your spare parts purchase via our website and use the codes in the coupons below to redeem and use your discount.

Happy flying!

There you will be able to find and buy the spare parts listed below.

Visit www.zero-x.com.au | www.zero-x.co.nz to make your purchase.

ZXMP-D500BACCW

ZXMP-D500BACW

ZXMP-D500BAT1820

ZXMP-D500FACCW

ZXMP-D500FACW

ZXMP-D500RBS

SPARE PART BACK ARM COUNTER CLOCKWISE

SPARE PART BACK ARM CLOCKWISE

REPLACEMENT BATTERY PACK

SPARE PART FRONT ARM COUNTER CLOCKWISE

SPARE PART FRONT ARM CLOCKWISE

SPARE PART ROTOR BLADES x4

THANK YOU FOR YOUR SUPPORT!

PLEASE VISIT OUR WEBSITE &
USE PROMO CODE:

OOPSIBROKEIT
to receive

50% OFF

your spare parts purchase!

THANK YOU FOR YOUR SUPPORT!

PLEASE VISIT OUR WEBSITE &
USE PROMO CODE:

OOPSIBROKEITAGAIN
to receive

50% OFF

your spare parts purchase!

24.0 WARRANTY TERMS & CONDITIONS

Our goods come with guarantees that cannot be excluded under the Australian Consumer Law. You are entitled to a replacement or refund for a major failure and for compensation for any other reasonably foreseeable loss or damage. You are also entitled to have the goods repaired or replaced if the goods fail to be of acceptable quality and the failure does not amount to a major failure.

This warranty is provided in addition to your rights under the Australian Consumer Law. Directed Electronics Australia Pty Ltd (Directed Electronics) warrants that this product is free from defects in material and workmanship for a period of 12 months from the date of purchase or for the period stated on the packaging. This warranty is only valid where you have used the product in accordance with any recommendations or instructions provided by Directed Electronics.

This warranty excludes defects resulting from alterations of the product, accident, misuse, abuse or neglect. In order to claim the warranty, you must return the product to the retailer from which it was purchased or if that retailer is part of a National network, a store within that chain, along with satisfactory proof of purchase. The retailer will then return the goods to Directed Electronics.

Directed Electronics will repair, replace or refurbish the product at its discretion. The retailer will contact you when the product is ready for collection. All costs involved in claiming this warranty, including the cost of the retailer sending the product to Directed Electronics, will be borne by you.

Email: admin@zero-x.com.au

INDEMNITY

You agree to defend, indemnify and hold harmless Zero-X and its subsidiaries and affiliates from and against any and all claims, proceedings, injuries, liabilities, losses, costs and expenses (including reasonable legal fees), including but not limited to, claims alleging negligence, invasion of privacy, copyright infringement and/or trademark infringement against Zero-X and its subsidiaries and affiliates, relating to or arising out of your breach of any provision of these terms, your misuse of Zero-X products or its services, or your unauthorized modification or alteration of products or software.

WARRANTY AND WARRANTY DISCLAIMER

Zero-X has a limited warranty, whereby Zero-X warrants to you and only to you that this Zero-X Action Camera will be free from defects in materials and workmanship for one (1) year from the date of your purchase (unless a longer warranty period is required by law). The specifics of this Zero-X limited warranty are covered in this manual.

To the extent possible under governing law, other than the above product warranty for the Zero-X Action Camera you understand and agree that the Zero-X services are provided on an "as is" and "as available" basis.

Zero-X makes no warranty that the Zero-X product and services will meet your requirements or that use of the Zero-X services will be uninterrupted, timely, secure or error-free. Nor does Zero-X make any warranty as to the accuracy or reliability of any information obtained through Zero-X (including third party content), that any defects in the Zero-X products or services be corrected or that the Zero-X products or Zero-X services will be compatible with any other specific hardware or service.

Further, Zero-X does not warrant that Zero-X products or services or Zero-X servers that provide you with data and content are free of viruses or other harmful components.

Zero-X also assumes no responsibility for and shall not be liable, for any damages caused by viruses that may infect your Zero-X. In the event of any loss, damage or injury, you will not look to Zero-X to compensate you or anyone else. You release and waive for yourself and your insurer all subrogation and other rights to recover against Zero-X arising as a result of the payment of any claim for loss, damage or injury.

Zero-X equipment and services do not cause and cannot eliminate occurrences of certain events, including, and Zero-X makes no guarantee or warranty, including any implied warranty of merchantability or fitness for a particular purpose, that the Zero-X equipment and services provided will detect or avert such incidents or their consequences.

Zero-X does not undertake any risk that you or property, or the person or property of others, may be subject to injury or loss if such an event occurs. The allocation of such risk remains with you, not Zero-X.

Other than the above product warranty for the Zero-X products, its suppliers disclaim all warranties of any kind, whether express, implied, or statutory, regarding the Zero-X services, including any implied warranty of title, merchantability, fitness for a particular purpose, or non-infringement of third party rights.

Because some jurisdictions do not permit the exclusion of implied warranties, the last sentence of this section may not apply to you.

Zero-X hereby further expressly disclaims all liability for any claims for service failures that are due to normal product wear, product misuse, abuse, product modification, improper product selection or your non-compliance with all applicable federal, state or local laws.

This warranty and warranty disclaimer give you specific legal rights, and you may have other rights that vary by state, province, or country. Other than as permitted by law, Zero-X does not exclude, limit or suspend other rights you have, including those that may arise from the nonconformity of a sales contract.

For a full understanding of your rights, you should consult the laws of your state, province, or country. For our Australian customers: Please note that this warranty is in addition to any statutory rights in Australia in relation to your goods which, pursuant to the Australian Consumer Law, cannot be excluded.

LIMITATIONS OF ZERO-X LIABILITY

Under no circumstances will Zero-X be liable in any way for any content, including, but not limited to, the loss of content, any errors or omissions in any content, or any loss or damage of any kind incurred in connection with use of or exposure to any content posted, emailed, accessed, transmitted, or otherwise made available via Zero-X.

Zero-X liability for damages, especially for breach of duty or obligation, delay in performance, non-performance, or malperformance shall be precluded, except when these are due to negligent breaches of any significant contractual duty or obligation on the part of Zero-X. Any liability for negligence is limited to direct losses usually and typically foreseeable in such case. Should the claim for damages be based on wilful or grossly negligent breach of contractual duty or obligation on the part of Zero-X, the preclusion and limitation of liability mentioned in the preceding sentences will not apply. The preceding preclusion and limitation of liability will also not apply to claims for damages arising out of loss of life, bodily injury or health impacts for which Zero-X may be liable, or for non-contractual liability.

Some states and countries do not allow the exclusion or limitation of incidental or consequential damages, so the above limitation or exclusion may not apply to you. Additionally, this provision is not intended to limit Zero-X's liability in the event of Zero-X's wilful or intentional misconduct.

Capture the skies.™



www.zero-x.com.au | www.zero-x.co.nz



All Images, Information and Content are
Copyright © 2022 Directed Electronics
Australia Pty Ltd. All Rights Reserved.

www.directed.com.au | www.directed.co.nz

© Zero-X v1.0 2022