

polaris

HD Drone with WIFI FPV

USER MANUAL



ZERO-X[®]

Capture the skies.™

ZERO-X IS A PROUD DRONE SAFETY ADVOCATE



Test your knowledge at knowyourdrone.gov.au

Be aware of local legislations and read the instructions carefully before using your drone. Keep yourself and others safe when flying your Zero-X drone. Always fly your drone within visual line-of-sight and only fly one drone at a time. Do not allow your view of the drone to be impaired eg: in rain, wind, snow, fog or low light. When flying your drone, please keep in mind the safety and privacy of others.

Do not get your drone wet, dusty or sandy. Do not touch your drone while it is powered on and when the rotor blades are turning.

For replacement parts batteries, blades, and accessories please visit your nearest Zero-X retailer or visit www.zero-x.com.au | www.zero-x.co.nz

CONTENTS

1.0 WELCOME.....	3
1.1 BEFORE YOU GET UP IN THE AIR.....	3
1.2 GENERAL SAFETY	3
2.0 PRODUCT CONTENTS	4
2.1 PRODUCT OVERVIEW.....	4
2.2 CONTROLLER OVERVIEW.....	5
3.0 BATTERY SAFETY	6
4.0 SETTING UP YOUR DRONE	8
4.1 INSTALLING THE BATTERY	8
4.2 INSTALLING ROTOR GUARDS.....	8
4.3 REMOTE CONTROL.....	9
4.4 FLIGHT SAFETY.....	9
4.5 SYNCING YOUR DRONE.....	9
4.6 YOUR DRONE IS READY TO TAKE OFF.....	10
5.0 FLYING YOUR DRONE.....	11
5.1 BASIC FLIGHT	11
5.2 TRIM FUNCTION	11
5.3 SPEED MODE.....	12
6.0 DOWNLOADING THE ZERO-X SWIFT+ APP TO YOUR MOBILE PHONE..	13
6.1 WHERE TO DOWNLOAD	13
6.2 ZERO-X SWIFT+ APP.....	13
6.3 CONNECTING TO THE DRONE WIFI.....	13
7.0 CAMERA / VIDEO FEATURES.....	14
7.1 VIEWING PHOTOS AND VIDEOS.....	14
7.2 CAMERA MODE	14
7.3 VIDEO MODE	14
8.0 360° FLIP	14
9.0 HEADLESS MODE	15
10.0 ONE KEY REVERSE	15
11.0 EMERGENCY / STOP.....	16
12.0 DRONE MAINTENANCE	16
13.0 REPLACING ROTOR BLADES	16
14.0 REPLACEMENT PARTS	17
15.0 WARRANTY TERMS & CONDITIONS.....	18

1.0 WELCOME

Thank You for purchasing a Zero-X Polaris Drone, get ready to have the time of your life! We're sure your Zero-X Drone will bring you a world of great experiences in the air. However, before you get started, please take the time to read the following safety warnings and operating instructions carefully. In this document, the Zero-X Polaris Drone will be referred to as the "Drone".

1.1 BEFORE YOU GET UP IN THE AIR

Before you familiarise yourself with your Drone, we ask that you read "**Battery Safety**" on page 6 before you start charging your Drone's battery.

1.2 GENERAL SAFETY

Please familiarise yourself with your local Drone legislation regarding Drone usage before you begin using your Zero-X Drone. Included in the package contents of your Zero-X Drone are the Australian CASA guidelines.

Please read this information carefully to make sure you are using your Drone within the parameters of your local regulations. Zero-X takes no responsibility for operation of this product outside of what is legally permissible in your area.

- **DO NOT** fly your Drone any closer than 30 metres from people, animals or buildings.
- Check to make sure you are no closer than 5.5 kilometres from any airfields or airports. For more information on CASA's Australian legislation visit: <http://www.casa.gov.au/>
- You must not fly your Drone higher than 120 metres (400 ft) above the ground.
- Only fly during the day and keep your Drone within your visual line-of sight.
- For information outside Australia please visit the website of your local aviation authority.
- **DO NOT** attempt to modify the Drone or components, as doing so will void your warranty and may even ruin your Drone.
- **DO NOT** use the Drone in wet, dusty or sandy conditions. These elements can damage the components of your Drone.
- Please **DO NOT** attempt to touch the Drone when the remote control is powered on, or if the rotor blades are turning.
- When flying your Drone, please keep in mind the privacy of others.

2.0 PRODUCT CONTENTS

1. Polaris Drone
2. Remote Control
3. Rotor Blades x 4
4. Rotor Guards x 4
5. USB AC Wall Charger
6. USB Charging Cable
7. Screw Driver
8. User Manual

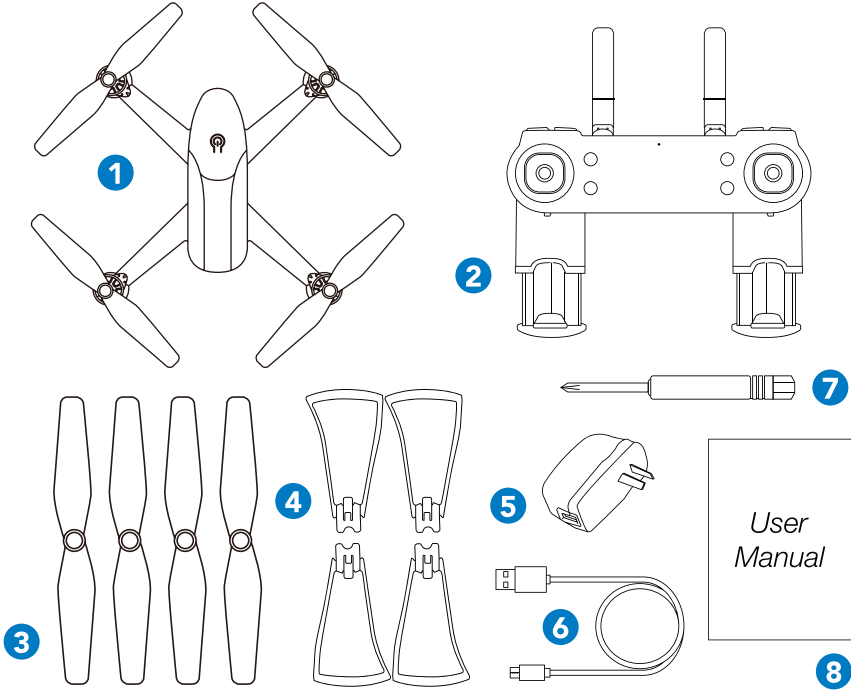

2.1 PRODUCT OVERVIEW

1. Camera
2. Rotor Blades
3. Motor
4. Power Button
5. Battery Release Button

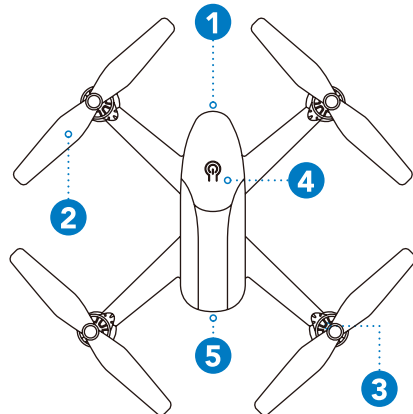

2.2 CONTROLLER OVERVIEW

1. Speed
2. Reverse
3. Left Control Stick (Pulse / Descend, Yaw Left / Right)
4. One Key Take Off / Landing
5. Emergency Stop
6. Right Control Stick (Forward / Backward, Left / Right)
7. Photo
8. Video
9. Headless Mode
10. 360° Flip
11. LED Power ON
12. ON / OFF

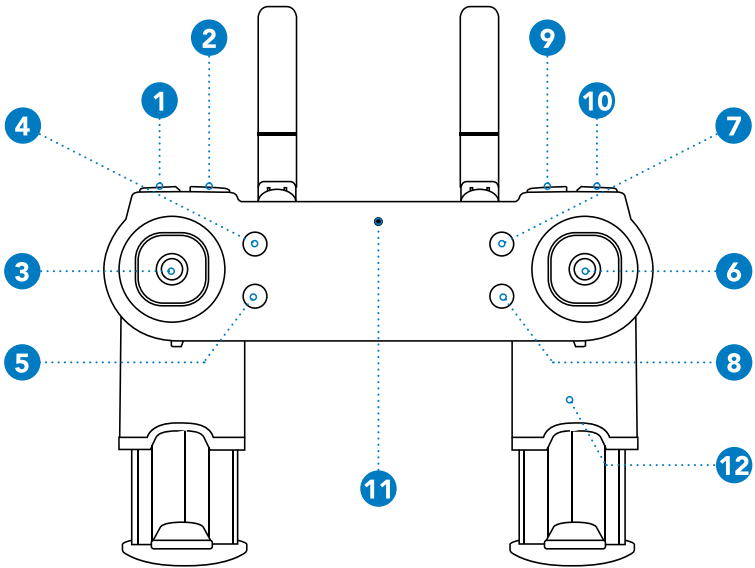

IMPORTANT INFORMATION - PLEASE READ BEFORE USE

3.0 BATTERY SAFETY

When handled incorrectly, Lithium polymer batteries can be dangerous and can potentially harm and do damage to persons or property. Zero-X does not accept any liability for damage to both persons or property if the battery is not correctly charged, stored or protected.

These are our suggestions to keep safe:

- Always unwind all cables before charging.
- **DO NOT** over charge the battery. Once charged, please remove the battery from the charger as soon as possible.
- Only use the included or replacement Polaris Drone chargers and batteries.
- You must charge the Lithium polymer battery in a safe area away from flammable materials.
- The battery is only to be charged under adult supervision, do not leave charging batteries unattended. Please keep aware of the charger during the process, and fix any issues or problems may occur.
- **DO NOT** charge the battery in temperatures hotter than 40°C or colder than 0°C.
- **DO NOT** cover the batteries when charging or leave them in direct sunlight.
- After each flight & or crash, please check batteries for any damage or swelling.
- If the battery is damaged, leaking, making noise, punctured or malformed in any way, please **DO NOT** attempt to use it. Please dispose of the battery immediately, correctly and safely.
- **DO NOT** bend, puncture, crush or scratch the Drone's battery. **DO NOT** store batteries in your pockets, on your person or in extreme temperatures.
- After flying/discharging the battery you must allow it to cool to ambient/room temperature before recharging.
- If the battery begins to balloon or swell, discontinue charging or discharging immediately. Quickly and safely disconnect the battery, then place it in a safe, open area away from flammable materials to observe it for at least 15 minutes. **Continuing to charge or discharge a battery that has begun to balloon or swell can result in a fire.** A battery that has ballooned or swollen even a small amount must be removed from service completely.
- Never plug in a battery and leave it to charge unattended overnight.
- Non-compliance with the above warnings may result in the failure of the battery and become dangerous.

PLEASE NOTE: YOUR ZERO-X DRONE COMES WITH A CERTIFIED ZERO-X USB AC CHARGING ADAPTER FOR 240V CHARGING OF YOUR DRONE BATTERY. USE OF A NON ZERO-X CERTIFIED USB AC CHARGING ADAPTER WILL VOID YOUR WARRANTY AND MAY DAMAGE BOTH YOUR BATTERY AND DRONE.

- Connect the Drone battery to the charging cable. The light will glow red indicating charging is in process. The LED on the USB charging cable will turn off once charging is complete.
- To maintain the battery life as long as possible, do not remove the battery from the charger before it has finished charging.
- If you have just finished flying your Drone, please allow the battery to cool down for at least 30 minutes before recharging. When the battery has finished charging it is advised that the battery is removed from the charger as soon as possible. Overcharging will damage the battery and may reduce flight time. The battery can take up to 50 minutes to fully charge. If the battery has been on charge for more than 2 hours and the indicator on the charging cable is not showing that the battery is charged, please remove the battery from the charger.

4.0 SETTING UP YOUR DRONE

4.1 INSTALLING THE BATTERY

For detailed instructions on how to install the battery please follow the steps below.

1. Ensure that the battery is fully charged.
2. Insert the battery into the rear of the Drone in the right direction (the tab on the battery should be facing down).
3. Slide the battery all the way in, until it securely slots into place.

NOTE:

- Do not force the battery. If the battery does not fit into position, please check that you have installed the battery in the correct orientation.

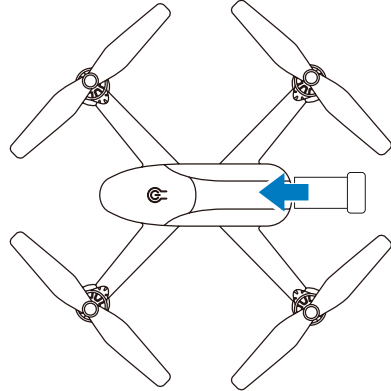

4.2 INSTALLING ROTOR GUARDS

Installing the rotor guards is optional, however installing them will protect your rotor blades and motors against bumps and light crashes.

1. To install the rotor guard, please insert the rotor guard pegs into the designated holes near the motors on the Drone's arms and tighten the screw.

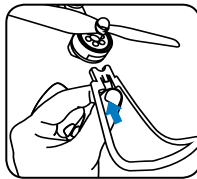

2. To remove the rotor guard, please unscrew the screws and then press the middle part of the rotor guard first, then take the rotor guard out.

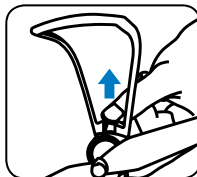

4.3 REMOTE CONTROL

1. Extend the arms of the remote control.
2. Remove the battery cover on the rear of the remote control by sliding it downward.
3. Insert 2 x AAA batteries (AAA batteries not included) making sure that they are in the orientation specified.

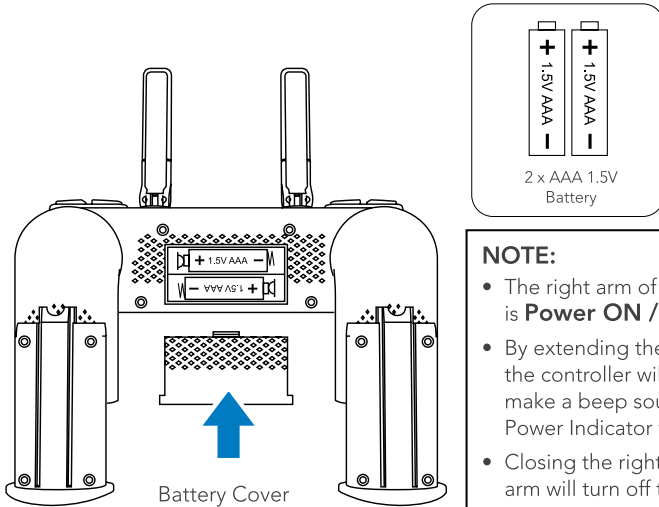

NOTE:

- The right arm of the controller is **Power ON / OFF**.
- By extending the arm lower, the controller will Power On make a beep sound and the Power Indicator will turn ON.
- Closing the right controller arm will turn off the controller.

4.4 FLIGHT SAFETY

Before flying your Drone make sure that you are in a safe setting. CASA restrictions regarding flying Drones require the Drone to be no closer than 5.5kms from any airport or airfield while flying. Drones should also not be flown over populated areas or any closer than 30 metres from vehicles, people or animals.

It is also required that you check your surroundings before taking off, by making sure there are no obstacles or dangers in the area including overhead power lines and large bodies of water. If there are hazards present in your intended area of flight, please find an alternative location.

4.5 SYNCING YOUR DRONE

1. Press the **ON/OFF BUTTON** on the top of the Drone to turn it ON. The LED light of the Drone will blink a blue colour (front) and a red colour (rear).
2. Extend the arms of the controller downwards, the controller will make a beeping sound and the LED indicator will Power On the controller.
3. Move the left control stick to the upside for **1 second** and then move the left control stick to the downside for **1 second**, the controller will beep and the LED light of the Drone will stop blinking. The LED will

change to solid blue in front and solid red in rear (Fig 1).

4. Please ensure that you have connected to your smartphone via WIFI before flying the Drone. Please refer to "**Connecting To The Drone WiFi**" on page 13.
5. Place the Drone on a flat surface, and hold the left and right control sticks inward & downward (left stick 5 o'clock and right stick 7 o'clock positions) for **3 seconds**. The indicator on the Drone will change from constant light to quick flashing lights. When the LED light of the Drone remains solid again, this means that the Drone has been calibrated successfully (Fig 2).

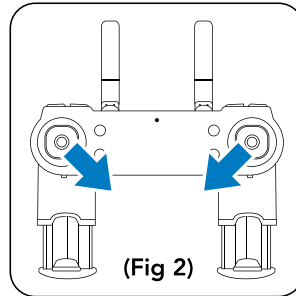
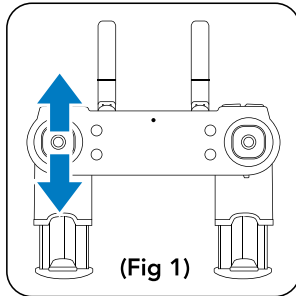

NOTE:

- Please repeat step 5 before every flight.
- Please pair the controller frequency within 5m of the Drone to avoid interference with other signals.

4.6 YOUR DRONE IS READY TO TAKE OFF

Please ensure that the Drone is kept on a flat surface and away from any obstructions.

There are two methods to begin flying your Drone:

1. Press the **ONE KEY TAKE OFF / LANDING BUTTON** (Fig 3).
2. Press the **LEFT and RIGHT CONTROL STICKS** outward and downward (left stick 7 o'clock and right stick 5 o'clock positions) (Fig 4) for **3 seconds**. The Drone blades will start rotating and the Drone is ready to fly by pushing the **LEFT CONTROL STICK** upwards (Fig 5).

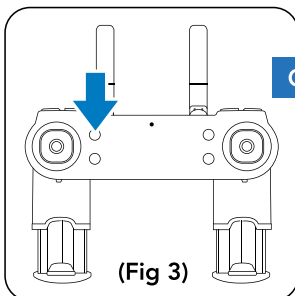

OR

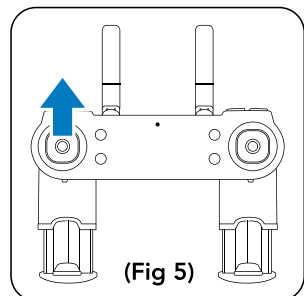
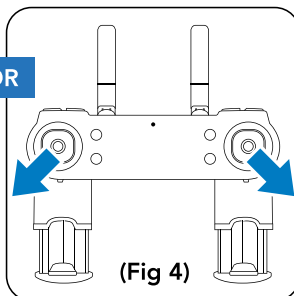

5.0 FLYING YOUR DRONE

5.1 BASIC FLIGHT

UP AND DOWN

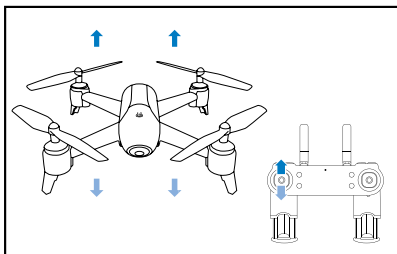

Push the left control stick up to gain altitude and down to descend

FORWARD AND BACKWARDS

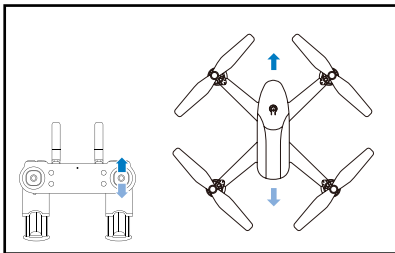

Push the right control stick up and down to fly forwards and backwards.

ROTATION

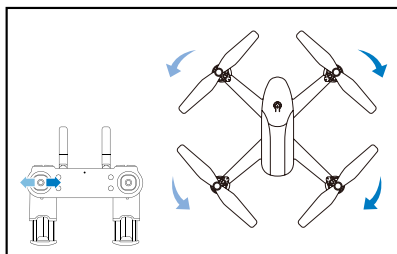

Push the left control stick left and right to pivot left/right.

LEFT / RIGHT FLIGHT

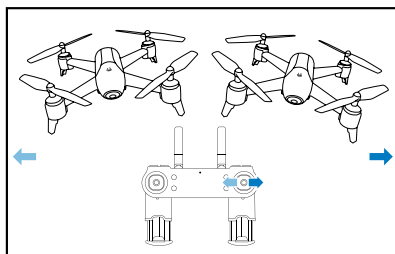

Push the right control stick left and right, to fly left/right.

5.2 TRIM FUNCTION

Trimming is used to balance out your Drone if it is drifting when flying. To adjust the Trimming please follow the steps below. **You can only use the Trim function when the Drone is airborne.**

1. Make sure that the remote control and Drone are switched on and correctly paired.
2. With the right control stick centered, push down on it, once you hear the stick button click, release it. *(This needs to be done each time you want to adjust trim in flight).*
3. You can now adjust your trim using your LEFT/RIGHT and UP/DOWN on your right controller stick. Please refer to (Fig 3, 4 & 5) on **page 10**.
4. To stop Trimming, press down on the right control stick again.

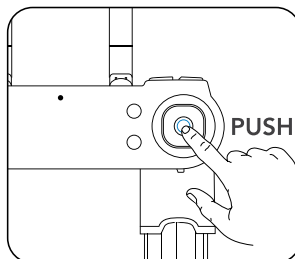

TRIM FORWARD / BACKWARD

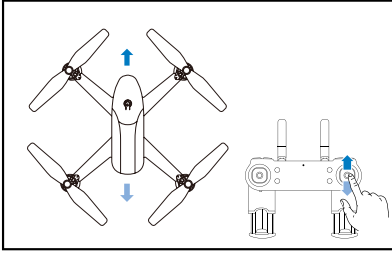

When the Drone is hovering in place, and starts to drift forward, press the right control stick backwards until it's stable. If it drifts backwards, press the right control stick forward until it's stable.

TRIM LEFT / RIGHT FLIGHT

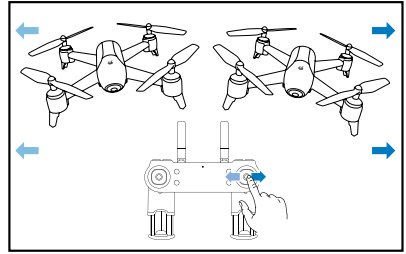

When the Drone is hovering and starts to drift to the side, push the right stick to the left/right until the Drone is stable.

LEFT / RIGHT TRIM

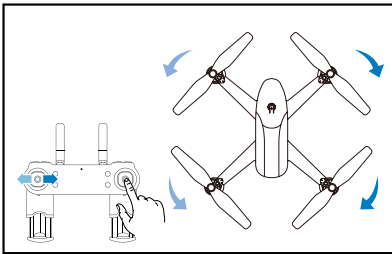

If the Drone keeps rotating to left, press the left direction stick to the right until it's stable. If the Drone keeps rotating to the right, press the left thumb stick to the left until it's stable.

5.3 SPEED MODE

The Drone has 3 speed modes.

To cycle through the Speed Modes, use the **SPEED BUTTON** on the top left of the controller.

- Each mode will be identifiable by a series of beeps.
- **Low Speed Mode (Default):** One beep.
- **Medium Speed Mode:** Two beeps.
- **High Speed Mode:** Three beeps.

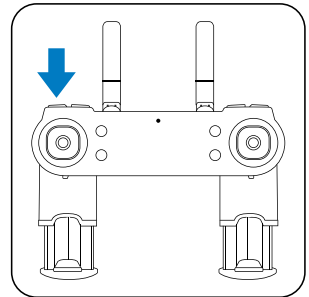

NOTE:

- For beginners it is suggested to operate the Drone at **Low Speed**.

6.0 DOWNLOADING THE ZERO-X SWIFT+ APP TO YOUR MOBILE PHONE

6.1 WHERE TO DOWNLOAD

For iPhones: Go to the Apple App Store and search for the ZX-SWIFT+ APP.

For Android phones: Go to the Google Play Store and search for the ZX-SWIFT+ APP.

6.2 ZERO-X SWIFT+ APP



The Drone has a built in WIFI connection which is used to wirelessly connect your Smartphone to your Drone allowing you to view the Drone camera's live view, trigger recording, control and fly your Drone.

To connect your Smartphone to the Drone please follow the instructions below.

1. Go to the Google Play store if you are using an Android Smartphone, or the Apple Store if you are using an iPhone and search for the App named "ZERO-X SWIFT+", once located please download and install the App.
2. Alternatively, please scan the QR code to download and install the App.



6.3 CONNECTING TO THE DRONE WIFI

1. Go to your mobile phone's settings menu and enter the WiFi settings.
2. Turn on your Drone.
3. If your WiFi is turned off, turn it on and search for ZX-POL_XXXXXXX in the available networks. Select ZX-POL_XXXXXXX, once the connection is successful a  icon will appear next to it.
4. Once connected, open the ZERO-X SWIFT+ APP on your smart phone.

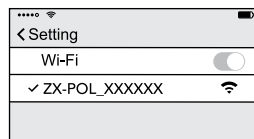

Minimum Smartphone Requirements (for use of the ZERO-X SWIFT+ APP). iPhone: iPhone 6 or later using iOS 8.0 and above. Samsung Galaxy: S5 and later using Mobile Android 5.0 and above. Minimum 3G network connection for GPS functionality. Apple, the Apple logo, and iPhone are trademarks of Apple Inc., registered in the U.S. and other countries. Google Play and the Google Play logo are trademarks of Google Inc. Industries.

7.0 CAMERA / VIDEO FEATURES

7.1 VIEWING PHOTOS AND VIDEOS

To view recorded footage and videos you will need to connect to the **ZERO-X SWIFT+ APP**.

7.2 CAMERA MODE

1. With the Drone turned on and paired, press the **PHOTO BUTTON**.
2. The remote control will beep once and the LED lights of the Drone will blink once to indicate that a photo was taken.

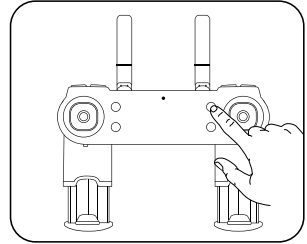

7.3 VIDEO MODE

1. With the Drone turned on and paired, press the **VIDEO BUTTON**.
2. The remote control will beep once and the LED lights on the Drone will blink continuously to indicate that a video is being recorded.
3. Press the **VIDEO BUTTON** again to stop recording and the LED light on the top camera of the Drone will stop blinking.

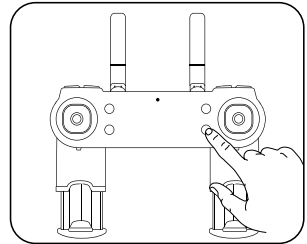

8.0 360° FLIP

Fly the Drone to a height of more than 3 metres, then press the **360° FLIP BUTTON** on the top right of your controller. Then immediately push the right controller stick in the direction you want to flip your Drone.

NOTE:

- 360° flips work better when the battery is fully charged.

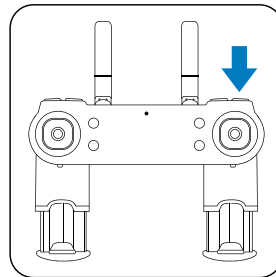
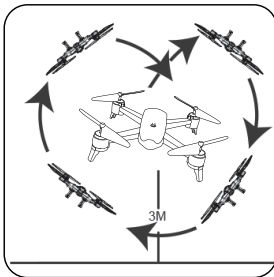

9.0 HEADLESS MODE

When HEADLESS MODE is enabled, the Drone will move in the direction that the remote controller stick is pressed, regardless of its orientation. This makes it easy to bring the Drone home when it is far away from you. To ensure headless mode works well, please use the correct take off position. The camera of the Drone must point in the intended direction of flight; the back of the Drone should be facing the pilot. See below instructions.

1. Press the HEADLESS MODE BUTTON on the controller (shown in the diagram to the right). The remote control will beep once indicating that HEADLESS MODE has been enabled. To stop headless mode, press the HEADLESS MODE BUTTON again; the controller will beep again.

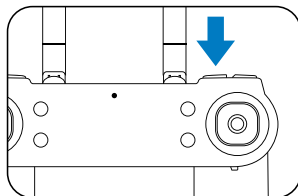

(Fig 6)

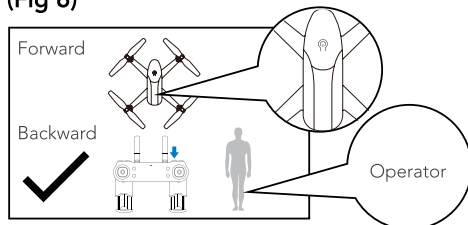

Correct take off position.

(Fig 7)

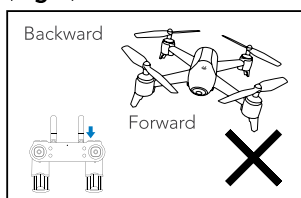

Incorrect take off position.

10.0 ONE KEY REVERSE

1. To ensure ONE KEY REVERSE works well, please ensure correct take off position as mentioned in section "HEADLESS MODE" on page 15 (Fig 6 & 7).
2. While the Drone is in flight, press the REVERSE BUTTON on the remote control, the controller will beep once and the Drone will fly in reverse.
3. Press the REVERSE BUTTON again to cancel or push the right control stick in any direction to stop this function.

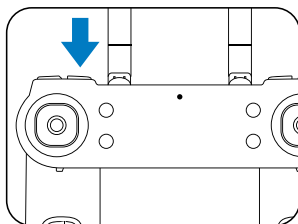

NOTE:

- It is highly recommended that you push the REVERSE BUTTON only when you are aware that it is safe to reverse.

11.0 EMERGENCY / STOP

1. While the Drone is airborne and emergency is activated, the rotor blades will lock and the Drone will fall to the ground.

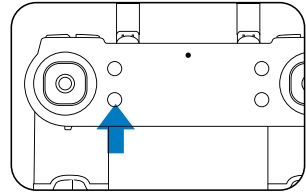

NOTE:

- It is highly recommended that you do not push this button unless it is an emergency.

12.0 DRONE MAINTENANCE

Avoid exposing your Drone and its accessories to dust, sand and moisture as these can damage the Drone. If the Drone is exposed to dust or sand, use a soft brush to remove any visible particles.

13.0 REPLACING ROTOR BLADES

If your rotor blades become damaged or the Drone is no longer flying straight, the rotor blades may need to be replaced. To replace the Drone's rotor blades, please follow the directions below.

There are two types of rotor blades included with the Drone, **A** blades (clockwise rotation) and **B** blades (counter clockwise rotation). The blades are marked on top showing either **A** or **B**. The arms of the Drone are marked **A** and **B**, showing what blades each motor is compatible with.

It is important that the rotor blades are installed on the designated motors or else the Drone may not fly and you could potentially burn out the Drone's motors.

To remove and replace the rotor blades, please follow the instructions below.

1. Remove the rotor blades by securing screw by unscrewing them counter clockwise with the screw driver (included).
2. Once the screw has been removed gently pull the rotor blade upward to remove the rotor blade from the motor stem.
3. Please ensure you identify and match the correct blade with the motor (**A** rotor blade to **A** motor, **B** rotor blade to **B** motor).
4. Place the new rotor blade over the motor stem and press it to ensure it is locked.
5. Replace and tighten the screw.

NOTE

- It is important that the correct rotor blades are installed on the correct motors. If they are installed incorrectly the Drone will not fly and you could potentially burn out the Drone's motors.
- When replacing multiple rotor blades please replace the blades one at a time to avoid any confusion in reattaching the rotor blades.

14.0 REPLACEMENT PARTS

We understand that it's not always easy learning how to fly a Drone. In rare occurrences, a 'close call' can turn into a crash landing. Accidents happen!

To thank you for your support of Zero-X and your Drone purchase, we would like to help you build your confidence in learning how to fly your Drone by offering you 50% off your first two orders of spare parts.

Simply make your spare parts purchase via our website and use the codes in the coupons below to redeem and use your discount.

Happy flying!

Listed below are our spare parts that are available for purchase.

Visit www.zero-x.com.au | www.zero-x.co.nz to make your purchase.

ZX-POLBAT600
ZX-POLMOCCW
ZX-POLMOCW
ZX-POLRBS
ZX-POLRGS
ZX-POLUSBCBL

REPLACEMENT BATTERY PACK
SPARE PART COUNTER CLOCKWISE MOTOR*2
SPARE PART CLOCKWISE MOTOR*2
SPARE PART ROTOR BLADES*4
SPARE PART ROTOR GUARDS*4
SPARE PART USB CABLE

THANK YOU FOR YOUR SUPPORT!

PLEASE VISIT OUR WEBSITE &
USE PROMO CODE:

OOPSIBROKEIT
to receive

50% OFF

your spare parts purchase!

THANK YOU FOR YOUR SUPPORT!

PLEASE VISIT OUR WEBSITE &
USE PROMO CODE:

OOPSIBROKEITAGAIN
to receive

50% OFF

your spare parts purchase!

15.0 WARRANTY TERMS & CONDITIONS

Our goods come with guarantees that cannot be excluded under the Australian Consumer Law. You are entitled to a replacement or refund for a major failure and for compensation for any other reasonably foreseeable loss or damage. You are also entitled to have the goods repaired or replaced if the goods fail to be of acceptable quality and the failure does not amount to a major failure.

This warranty is provided in addition to your rights under the Australian Consumer Law. Directed Electronics Australia Pty Ltd (Directed Electronics) warrants that this product is free from defects in material and workmanship for a period of 12 months from the date of purchase or for the period stated on the packaging. This warranty is only valid where you have used the product in accordance with any recommendations or instructions provided by Directed Electronics.

This warranty excludes defects resulting from alterations of the product, accident, misuse, abuse or neglect. In order to claim the warranty, you must return the product to the retailer from which it was purchased or if that retailer is part of a National network, a store within that chain, along with satisfactory proof of purchase. The retailer will then return the goods to Directed Electronics.

Directed Electronics will repair, replace or refurbish the product at its discretion. The retailer will contact you when the product is ready for collection. All costs involved in claiming this warranty, including the cost of the retailer sending the product to Directed Electronics, will be borne by you.

Email: admin@zero-x.com.au

INDEMNITY

You agree to defend, indemnify and hold harmless Zero-X and its subsidiaries and affiliates from and against any and all claims, proceedings, injuries, liabilities, losses, costs and expenses (including reasonable legal fees), including but not limited to, claims alleging negligence, invasion of privacy, copyright infringement and/or trademark infringement against Zero-X and its subsidiaries and affiliates, relating to or arising out of your breach of any provision of these terms, your misuse of Zero-X products or its services, or your unauthorized modification or alteration of products or software.

WARRANTY AND WARRANTY DISCLAIMER

Zero-X has a limited warranty, whereby Zero-X warrants to you and only to you that this Zero-X Action Camera will be free from defects in materials and workmanship for one (1) year from the date of your purchase (unless a longer warranty period is required by law). The specifics of this Zero-X limited warranty are covered in this manual.

To the extent possible under governing law, other than the above product warranty for the Zero-X Action Camera you understand and agree that the

Zero-X services are provided on an “as is” and “as available” basis.

Zero-X makes no warranty that the Zero-X product and services will meet your requirements or that use of the Zero-X services will be uninterrupted, timely, secure or error-free. Nor does Zero-X make any warranty as to the accuracy or reliability of any information obtained through Zero-X (including third party content), that any defects in the Zero-X products or services be corrected or that the Zero-X products or Zero-X services will be compatible with any other specific hardware or service.

Further, Zero-X does not warrant that Zero-X products or services or Zero-X servers that provide you with data and content are free of viruses or other harmful components.

Zero-X also assumes no responsibility for and shall not be liable, for any damages caused by viruses that may infect your Zero-X. In the event of any loss, damage or injury, you will not look to Zero-X to compensate you or anyone else. You release and waive for yourself and your insurer all subrogation and other rights to recover against Zero-X arising as a result of the payment of any claim for loss, damage or injury.

Zero-X equipment and services do not cause and cannot eliminate occurrences of certain events, including, and Zero-X makes no guarantee or warranty, including any implied warranty of merchantability or fitness for a particular purpose, that the Zero-X equipment and services provided will detect or avert such incidents or their consequences.

Zero-X does not undertake any risk that you or property, or the person or property of others, may be subject to injury or loss if such an event occurs. The allocation of such risk remains with you, not Zero-X.

Other than the above product warranty for the Zero-X products, its suppliers disclaim all warranties of any kind, whether express, implied, or statutory, regarding the Zero-X services, including any implied warranty of title, merchantability, fitness for a particular purpose, or non-infringement of third party rights.

Because some jurisdictions do not permit the exclusion of implied warranties, the last sentence of this section may not apply to you.

Zero-X hereby further expressly disclaims all liability for any claims for service failures that are due to normal product wear, product misuse, abuse,

product modification, improper product selection or your non-compliance with all applicable federal, state or local laws.

This warranty and warranty disclaimer give you specific legal rights, and you may have other rights that vary by state, province, or country. Other than as permitted by law, Zero-X does not exclude, limit or suspend other rights you have, including those that may arise from the nonconformity of a sales contract.

For a full understanding of your rights, you should consult the laws of your state, province, or country. For our Australian customers: Please note that this warranty is in addition to any statutory rights in Australia in relation to your goods which, pursuant to the Australian Consumer Law, cannot be excluded.

LIMITATIONS OF ZERO-X LIABILITY

Under no circumstances will Zero-X be liable in any way for any content, including, but not limited to, the loss of content, any errors or omissions in any content, or any loss or damage of any kind incurred in connection with use of or exposure to any content posted, emailed, accessed, transmitted, or otherwise made available via Zero-X.

Zero-X liability for damages, especially for breach of duty or obligation, delay in performance, non-performance, or malperformance shall be precluded, except when these are due to negligent breaches of any significant contractual duty or obligation on the part of Zero-X. Any liability for negligence is limited to direct losses usually and typically foreseeable in such case. Should the claim for damages be based on willful or grossly negligent breach of contractual duty or obligation on the part of Zero-X, the preclusion and limitation of liability mentioned in the preceding sentences will not apply. The preceding preclusion and limitation of liability will also not apply to claims for damages arising out of loss of life, bodily injury or health impacts for which Zero-X may be liable, or for non-contractual liability.

Some states and countries do not allow the exclusion or limitation of incidental or consequential damages, so the above limitation or exclusion may not apply to you. Additionally, this provision is not intended to limit Zero-X's liability in the event of Zero-X's willful or intentional misconduct.

Capture the skies.™

ZERO-X™

ANOTHER
DIRECTED
BRAND

www.zero-x.com.au | www.zero-x.co.nz



All Images, Information and Content are
Copyright © 2022 Directed Electronics
Australia Pty Ltd. All Rights Reserved.

www.directed.com.au | www.directed.co.nz

© Zero-X v1.0 2022