

e5en

USER MANUAL



30 MIN
Flight Time

600 M
Flight Range

FHD
1080p Video

AUTOPILOT
NAVIGATION

AUTO
GIMBAL

BRUSHLESS
MOTOR

CARRY
CASE

ZERO-X | **PRO**

ZXMP-D400

ZERO-X IS A PROUD DRONE SAFETY ADVOCATE



Test your knowledge at knowyourdrone.gov.au

Be aware of local legislations and read the instructions carefully before using your drone. Keep yourself and others safe when flying your Zero-X drone. Always fly your drone within visual line-of-sight and only fly one drone at a time. Do not allow your view of the drone to be impaired eg: in rain, wind, snow, fog or low light. When flying your drone, please keep in mind the safety and privacy of others.

Do not get your drone wet, dusty or sandy. Do not touch your drone while it is powered on and when the rotor blades are turning.

For replacement parts batteries, blades, and accessories please visit your nearest Zero-X retailer or visit www.zero-x.com.au | www.zero-x.co.nz

CONTENTS

1.0 WELCOME	4
1.1 BEFORE YOU GET UP IN THE AIR	4
1.2 GENERAL SAFETY	4
2.0 PRODUCT CONTENTS	5
2.1 PRODUCT OVERVIEW	5
2.2 REMOTE CONTROL OVERVIEW	6
3.0 BATTERY SAFETY	7
4.0 INSTALLING THE BATTERY	9
5.0 SETTING UP YOUR DRONE	9
5.1 INSTALLING A MICRO SD CARD*	9
5.2 REMOVING A MICRO SD CARD	9
5.3 REMOVING GIMBAL PROTECTIVE COVER	10
5.4 FOLDING/UNFOLDING THE DRONE	10
5.5 REMOTE CONTROL	10
6.0 FLIGHT SAFETY	10
7.0 FLYING YOUR DRONE	11
7.1 FLYING THE DRONE WITHOUT GPS	11
7.2 FLYING THE DRONE WITH GPS	12
7.3 BASIC FLIGHT	14
7.4 TRIMMING WITH NO GPS	14
7.5 SPEED MODE	15
7.6 ADJUSTING CAMERA ANGLE	15
7.7 TAKING OFF/LANDING AND EMERGENCY LANDING	16
7.8 HEADLESS MODE	16
7.9 FLY AROUND-ME MODE	17
8.0 ZERO-X ASCEND APP	17
9.0 FOLLOW-ME FUNCTION (GPS MODE ENABLED)	18
9.1 ACTIVE TRACK	18
9.2 WAY POINT FLIGHT (GPS MODE ENABLED)	19
9.3 RETURN HOME (GPS MODE ENABLED)	19
9.3.1 SMART RETURN TO HOME	19
9.3.2 LOW BATTERY RETURN TO HOME	19
9.4 PHOTO MODE	20
9.5 VIDEO MODE	20

9.6 VIEWING PHOTOS AND VIDEOS 20

9.7 HAND GESTURE 20

10.0 ACTIVATING THE SEARCH FUNCTION FOR A LOST DRONE 20

11.0 DRONE MAINTENANCE 21

12.0 REPLACING ROTOR BLADES 21

13.0 REPLACEMENT PARTS 22

14.0 WARRANTY TERMS AND CONDITIONS 23

1.0 WELCOME

Thank You for purchasing a Zero-X Drone. The Zero-X range has been specifically designed to provide the intermediate to advanced user with a great flight experience. Please take the time to read the following safety warnings and operating instructions carefully. In this document, the Zero-X Pro Drone will be referred to as the "Drone".

1.1 BEFORE YOU GET UP IN THE AIR

Before you familiarise yourself with your Zero-X Drone, we ask that you read "**BATTERY SAFETY**" on **page 7** before you start charging your Drone's battery.

WARNING: PLEASE DO NOT MOVE THE CAMERA MANUALLY AS IT CAN DAMAGE THE GIMBAL AND CAMERA.

1.2 GENERAL SAFETY

Please familiarise yourself with your local Drone legislation regarding its usage before you begin using your Zero-X Drone. Included in the package contents of your Zero-X Drone are the Australian CASA guidelines. Please familiarise yourself with your local Drone legislation and make sure you are using your Drone within the parameters of these laws. Zero-X takes no responsibility for operation of this product outside of what is legally permissible in your area.

- **DO NOT** fly your Drone any closer than 30 metres from people, animals or buildings.
- Check to make sure you are no closer than 5.5 kilometres from any airfields or airports. For more information on CASA's Australian legislation visit: <http://www.casa.gov.au/>
- You must not fly your Drone higher than 120 metres above the ground.
- Only fly during the day and keep your Drone within your line-of sight.
- For Drone information outside Australia please visit the website of your local aviation authority.
- **DO NOT** attempt to modify the Drone or any of its components in any way, as doing so will void your warranty and may affect the operation of the Drone.
- **DO NOT** use the Drone in any conditions that could affect or damage your Drone. Wind, sand and dust can damage the components of your Drone.
- Please **DO NOT** attempt to touch the Drone when the remote control is powered on, or while the rotor blades are turning.
- When flying your Drone, please keep in mind the privacy of others.

2.0 PRODUCT CONTENTS

1. Zero-X Pro Drone
2. Remote Control
3. Rotor Blades x 4
4. USB AC Wall Charger
5. USB Charging Cable
6. User Manual
7. Screws
8. Screwdriver
9. Carry Case
10. Batteries x 2
11. Gimbal Protective Cover
12. Battery Charging Station

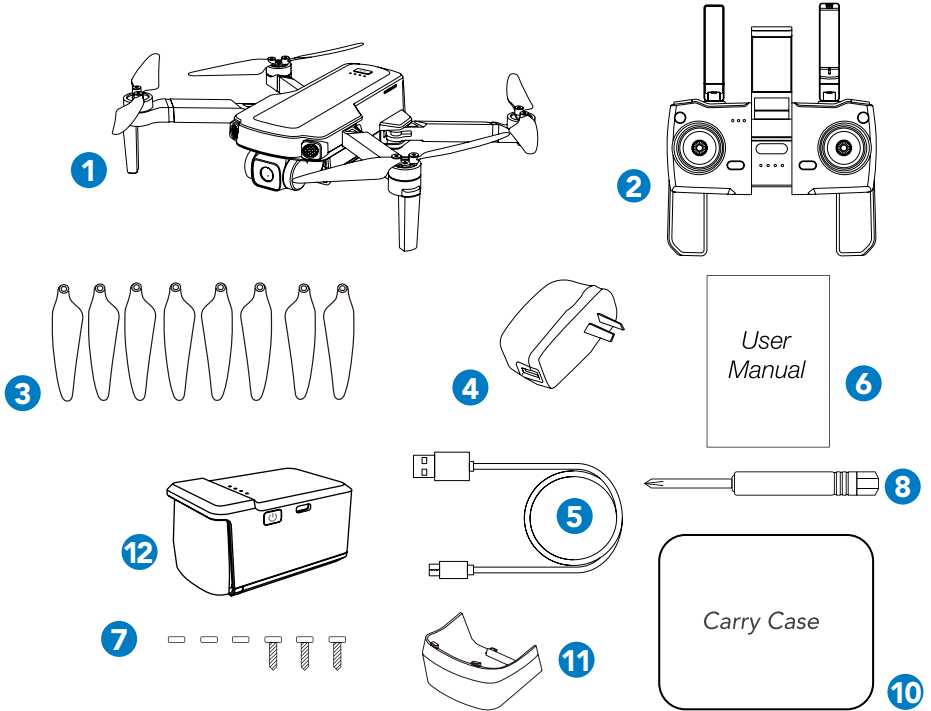

2.1 PRODUCT OVERVIEW

1. Camera
2. Rotor blades
3. Motor
4. Power Button
5. Battery Release Button
6. Gimbal Protective Cover

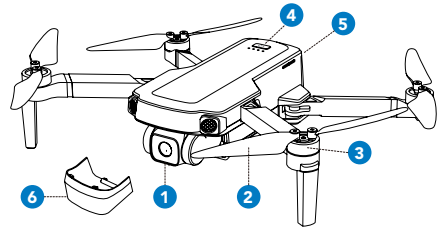

2.2 REMOTE CONTROL OVERVIEW

1.  Headless Mode
2. Left Thumb Stick
(Ascend/Descend, Yaw left/Right)
3.  Return to Home
4.  Power Button
5. Direction Controls
(Forward/Reverse, Left/Right)
6. **STOP** Emergency Stop Button
7.  Photo
8.  Video
9. Speed Select
10. Camera Up/Down
11. Full Charge: Green light
12. Charging: Red Light
13. Power Light: White
14. Return Home
15. Speed
16. Photo/Video
17. Headless Mode/Trim
18. Antenna

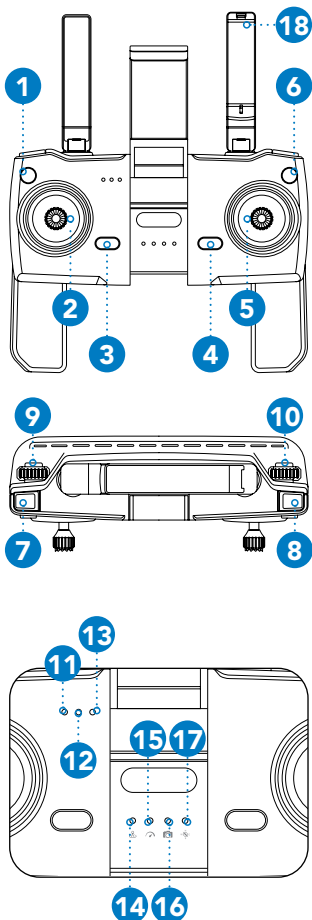

If you need to switch from DEFAULT mode, please push the  button and hold, then press the  button to turn on the remote control. Switching from default mode, the following functions will swap:

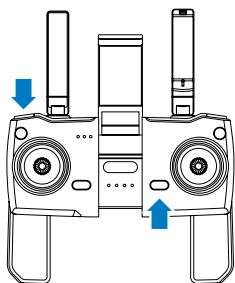

Ascend/Descend > Forward/Reverse
 Forward/Backward > Ascend/Descend

IMPORTANT INFORMATION - PLEASE READ BEFORE USE

3.0 BATTERY SAFETY

When handled incorrectly, Lithium polymer batteries can be dangerous and can potentially harm persons and / or property. Zero-X does not accept any liability for damage to persons and/ or property, if the battery is not correctly charged, stored or protected.

These are our suggestions to keep safe:

- Always unwind all cables before charging.
- **DO NOT** over charge the battery. Once the charging process is completed, remove the battery from the charger.
- Only use the included or replacement Zero-X chargers and batteries.
- You must charge the Lithium polymer battery in a safe area away from flammable materials.
- The battery is only to be charged under adult supervision. Do not leave charging batteries unattended. Remain aware of the charging process so you can react immediately to any problems that may occur.
- **DO NOT** charge the battery in temperatures higher than 40°C or lower than 0°C.
- **DO NOT** cover the batteries when charging. **DO NOT** leave batteries in direct sunlight.
- After each flight and / or crash, please check battery for any damage or swelling.
- If the battery is damaged, leaking, making noises, punctured or malformed in any way **DO NOT** attempt to use it. Please dispose of the battery immediately and safely in the correct manner.
- **DO NOT** bend, puncture, crush or scratch the Drone's battery. **DO NOT** store batteries in your pockets, on you or in extreme temperatures.
- After flying/discharging the battery you must allow it to cool to ambient/room temperature before recharging.
- If at any time during the charge or discharge process the battery begins to balloon or swell, discontinue charging or discharging immediately. Quickly and safely disconnect the battery, then place it in a safe, open area away from flammable materials to observe it for at least 15 minutes. **Continuing to charge or discharge a battery that has begun to balloon or swell can result in a fire.** A battery that has ballooned or swollen even in a small amount must be removed from service completely.
- Never plug in a battery and leave it to charge unattended overnight.
- Non-compliance with the above warnings may result in the failure of the battery and it becoming dangerous.

PLEASE NOTE: YOUR ZERO-X DRONE COMES WITH A CERTIFIED ZERO-X USB AC CHARGING ADAPTOR FOR 240V CHARGING OF YOUR DRONE BATTERY. USE OF A NON ZERO-X CERTIFIED USB AC CHARGING ADAPTOR WILL VOID YOUR WARRANTY AND MAY DAMAGE BOTH THE BATTERY AND DRONE.

- Press the buckle and pull out the battery from the your Drone.
- Insert the battery in the charging station. Power on the charging hub by connecting with provided cable and Adaptor. The light on the battery will become solid blue once charging is complete.
- Once the battery is in a low power state, the blue power indicator will start to blink. At this time, please fly back the Drone immediately and charge the battery to avoid unnecessarily losing your Drone.
- To keep the battery life as long as possible avoid removing the battery from the charging cable before charging is complete. If you have just finished flying your Drone, please allow the battery to cool down for at least 30 minutes before recharging.
- The Drone battery may take up to 2.5 hours to fully charge. If the battery has been on charge for any longer than 3.5 hours and the indicator on the charging cable is not showing that the battery is charged, please remove the battery from the charger.
- When the Drone battery has finished charging it is advised that the battery is removed from the charger as soon as possible. Overcharging will damage the battery and affect the flight time.

NOTE:

To protect battery if left charging for an extended time, a self-discharge function activates. After full charge is reached, charging will drop to a safe voltage to prevent damage.

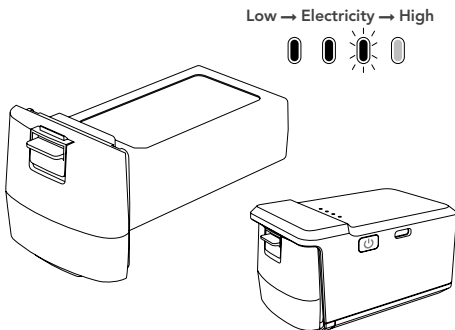

1. Battery power indicator
2. Click the power-on to see the amount of electricity, and then keep pressing the power-on for 2 seconds
3. USB-C charging port

Low → High



4.0 INSTALLING THE BATTERY

1. Ensure that the battery is fully charged.
2. Insert the battery into the rear of the Drone in the correct direction
3. Remove the battery, press the buckle and then take out the battery.
4. For taking out the battery, press the buckle and then take out the battery

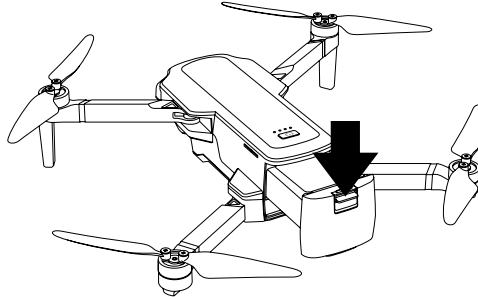

NOTE

- Do not force in the battery. If the battery does not fit into its position, please check that you have inserted the battery in the correct way.

5.0 SETTING UP YOUR DRONE

5.1 INSTALLING A MICRO SD CARD*

The Micro SD Card slot is at the bottom right side of the Drone.

1. Slide the Micro SD Card into the slot at the right side of the Drone with the Micro SD Card copper contacts facing toward the Drone. Gently press the card in, until you hear the lock **'click'** into place.

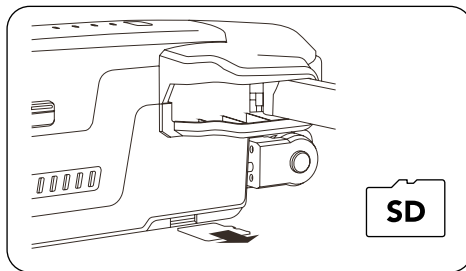

5.2 REMOVING A MICRO SD CARD

To remove your Micro SD Card, follow the instructions below.

1. Press the Micro SD Card in, until a click is heard and the card is released.
2. Once the Micro SD Card is released, it can be safely removed. (Please note that the Micro SD Card is not included).

5.3 REMOVING GIMBAL PROTECTIVE COVER

The Drone comes with a protective cover over the gimbal. Before flying your Drone, please remove the gimbal protective cover.

1. With the Drone upside down, gently pull the protective cover away from the body of the gimbal as shown below.

NOTE:

- Once the protective cover has been removed and the Drone is powered on, do not touch the gimbal.
- The gimbal contains precision parts and if damaged this may affect performance.

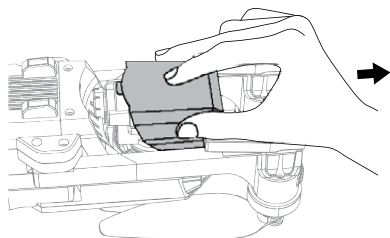

WARNING: DO NOT TOUCH THE GIMBAL WITH YOUR HAND

Once you have finished flying your Drone, please place the protective cover back over the gimbal so that it is protected during transit.

5.4 FOLDING/UNFOLDING THE DRONE

The Drone can be folded for easy storage and transport.

The Drone's arms are designed to be folded down in a specific order by first folding the forward arms inward and then folding the rear arms inward.

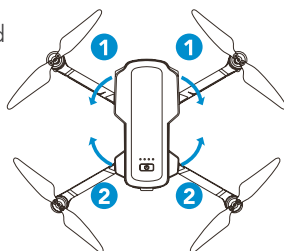

5.5 REMOTE CONTROL

The remote control comes with a rechargeable built-in Li poly 3.7V 300mAh battery. When the remote control is low in power, the power indicator light on the remote control will keep on blinking to indicate that it is time to charge the remote control.

1. Connect the remote control to the charging cable and the light will glow red indicating charging is in process. The power light on the remote will turn green once charging is complete. The remote control can take up to 50 minutes to fully charge.

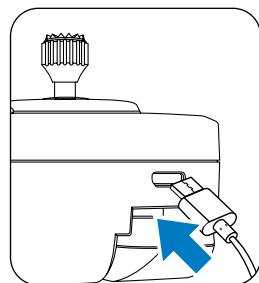

NOTE:

- To Power On, please press the  button
- To Power Off, short press the  button before long pressing for **3 seconds**.

6.0 FLIGHT SAFETY

Before flying your Drone make sure that you are in a safe setting. CASA restrictions regarding flying drones require the Drone to be no closer than 5.5 kilometres from any airport or airfield while flying. Drones should also not be flown higher than 120 metres above the ground, over populated areas or any closer than 30 metres from vehicles, people or animals.

It is vital you check your surroundings before taking off, and make sure there are no obstacles or dangers in the area including overhead power lines and bodies of water. If there are hazards in your intended area of flight, find an alternative location.

For safety, default control of the Drone is set to '**Beginner**' where the flight parameters are fixed.

To change the parameters, please deselect the Beginner mode in the App's Flight Settings. To download the App please refer to "**8.0 Zero-X Ascend App**" on page 18.

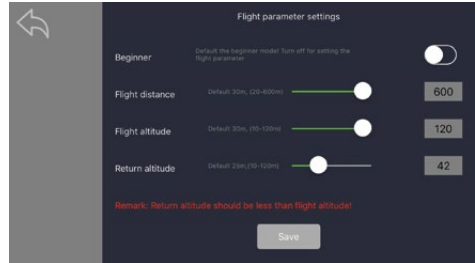

7.0 FLYING YOUR DRONE

Ensure that the Drone arms are fully extended and the batteries of your Drone and remote control are fully charged.

Please read through the instructions below before attempting to start and launch the Drone.

7.1 FLYING THE DRONE WITHOUT GPS

1. Adjust the top antennas of the remote control to the fully extended position.
2. Power on the Drone by holding the **⏻ button** for **3 seconds** and place the Drone on a level section of ground free of any obstacles. The LED light of Drone should be blinking in blue. It indicates that the Drone needs to be paired to the remote control.
3. Turn on the remote control by pressing the **⏻ button**. Move the left thumb stick upwards for **1 second** then move the left thumb stick downward for **1 second**. The remote control will beep and the lights on arms of Drone will slowly blink alternately in blue between the front and rear. It means the remote control and the Drone have been paired successfully. Release the left thumb stick allowing it to return to the natural position.

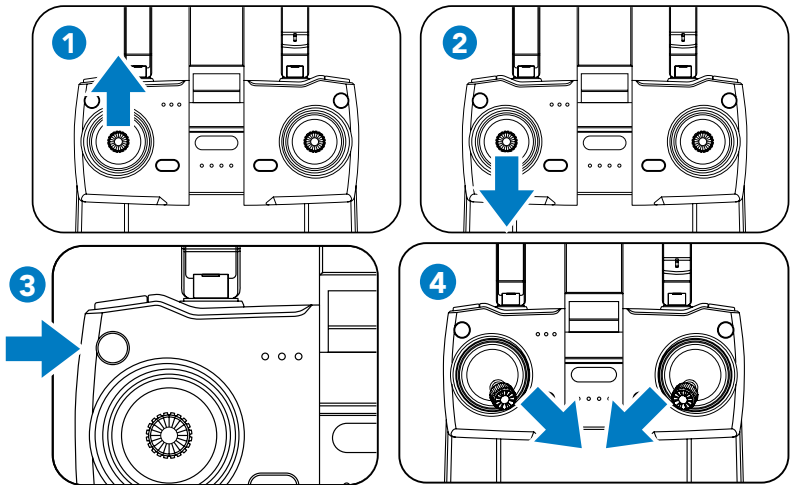

4. Press the **⏻ button** on the remote control for **3 seconds** until the remote control beeps and the lights on arms of Drone will start to slowly blink in blue at the rear and stay a constant red at the front. This indicate that GPS mode has been turned off when all of the GPS functions have been disabled. Unlock the motors by simultaneously holding the left thumb stick down to the 5 o'clock position while also holding the right thumb stick down to the 7 o'clock position. The motors will now start to spin. To launch the Drone push the left thumb stick upwards within **5 seconds** of the motors being unlocked.

NOTE FOR INDOOR FLYING:

- Sometimes there may be an imbalance in air pressure when flying indoors, so you will need to further calibrate the Drone to ensure optimum flight performance. Press the **W^NE** button on the remote control for **3 seconds** and if the lights on the arms and rear of the Drone start to blink in blue and stay a constant blue at the front (Please refer to point 6-8 on page 14).
- If you press the **W^NS** button for **3 seconds** and the lights on the arms of the Drone start to blink in blue at the rear and stay a constant blue at the front, then there is no need to do any indoor calibration.

NOTE:

- You can connect to the Wi-Fi at this time to view the real time video. Please refer to "**Zero-X Ascend App**" on **page 18** on how to connect to Wi-Fi.

7.2 FLYING THE DRONE WITH GPS

The Drone needs to record its starting position coordinates before flight and it is recommended to calibrate your Drone's GPS before starting every flight. See below for steps to calibrate the GPS.

1. Power on the Drone by holding the **⏻** button for **3 seconds** and place the Drone on a level section of ground that is free of any obstacles. The LED light of Drone should blink in blue. It indicates that the Drone needs to be paired to the remote control.
2. Turn on the remote control by pressing the **⏻** button. Move the left thumb stick upwards for **1 second** then move the left thumb stick downwards for **1 second**. The remote control will beep twice and the lights on the arms of the Drone will begin to blink slowly and alternately in blue at the front and rear. It means the remote control and the Drone have been paired successfully. Release the left thumb stick and allow it to return to the natural position. (Fig 1 and 2 below).

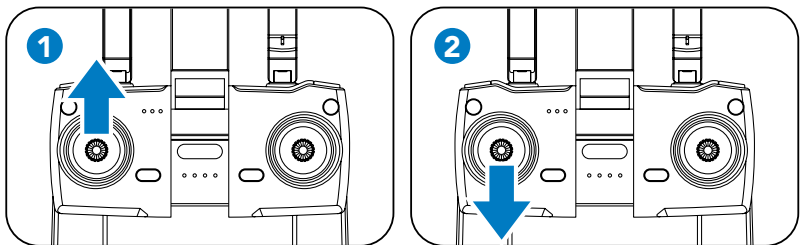

3. Connect to the Wi-Fi of the Drone and open the App to view real time information. Please check **page 18** for App connection (Optional).
4. Simultaneously hold the left thumb stick up and to the right (2 o'clock) while holding the right thumb stick up and to the left (11 o'clock). The lights on the arms of the Drone will quickly blink in blue/red at the front and blue/blue at the rear. The App status will change to: "**Compass Calibration**". (Fig 3 on the next page).

- To begin horizontal calibration, pick up the Drone and rotate it horizontally clockwise with the front camera facing away from you until the bottom lights switch to a constant blue/red. (Fig 4 below).

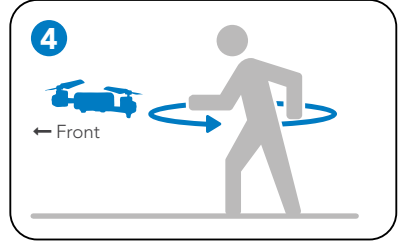
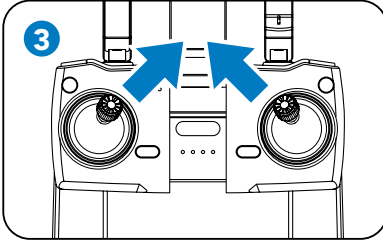

- To begin vertical calibration, pick up the Drone and face the front camera towards the ground. (Fig 5 below).
- Rotate the Drone on its vertical axis continuously. The blue lights at the front and rear will come on with the App status: **"Compass Calibration Okay"**. The Drone has been calibrated and will start searching for the GPS, and the LED light on the Drone arm will continue to blink slowly in blue. This process will take some minutes depending on conditions. The Drone must be outdoors for GPS connection to function correctly.
- App status: **"Waiting for GPS signal"**.
- Once the lights on the Drone arms turn to a constant blue at the front and rear and the App status turns to: **"Ready to Fly,"** then the Drone is ready for take off. Unlock the motors by simultaneously holding the left thumb stick down to 5 o'clock position while also holding the right thumb stick down to 7 o'clock position. (Fig 6 below).

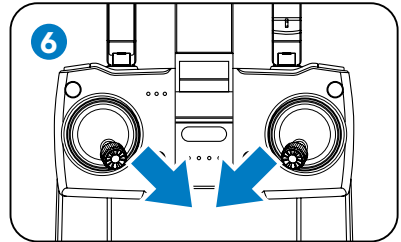
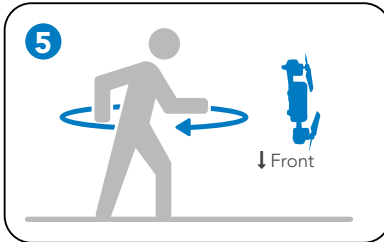

- The motors will now start to spin. To launch the drone, push the left thumb stick upward within **5 seconds** of the motors being unlocked.

NOTE:

- Please ensure a safe distance from the Drone before unlocking its motors.

7.3 BASIC FLIGHT

UP AND DOWN

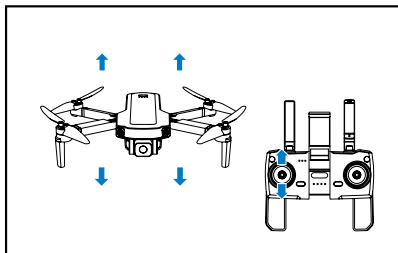

Push the left control stick up to gain altitude and down to descend.

FORWARD AND REVERSE

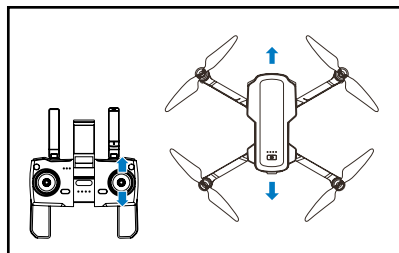

Push the right control stick up and down to fly forward and reverse.

ROTATION

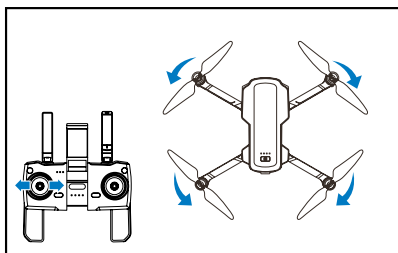

Push the left control stick left and right to pivot left/right.

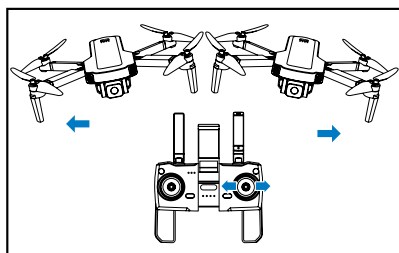

LEFT/RIGHT FLIGHT



Push the right control stick left and right to fly left/right.

7.4 TRIMMING WITH NO GPS

Trimming is used to balance the Drone when its flight is off centre.

1. Press the  button for **3 seconds** and you will enter the trim mode, then press the direction stick to trim the Drone.
2. To stop trimming, press the  button again.

NOTE:

- Trimming is only available during NO GPS mode.

TRIM FORWARD/REVERSE

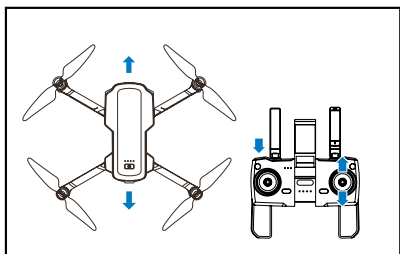

When the Drone is hovering in place, and starts to drift forward, press the right control stick backwards until it is stable. If it drifts backwards, press the right control stick forward until it is stable.

7.5 SPEED MODE

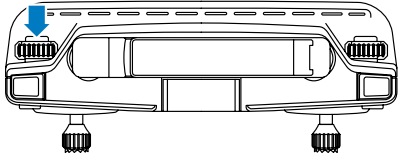

The Drone has 2 speed modes that control the acceleration and maneuverability of the Drone.

To cycle through the speed modes, use the **SPEED BUTTON** at the top left of the remote control.

7.6 ADJUSTING CAMERA ANGLE

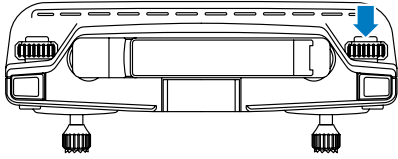

In order to record the scene from different angles, the Drone has an automatic camera gimbal.

Spin the camera angle button to adjust the camera up and down, so that you can view and record from different angles.

WARNING: PLEASE DO NOT MANUALLY MOVE THE CAMERA AS IT CAN DAMAGE THE GIMBAL AND CAMERA.

7.7 EMERGENCY LANDING

When the Drone has been paired successfully and the motors have been unlocked, the rotor blades will start to spin.

- Press the **STOP button** on the remote control for **3 seconds** to enact an Emergency Landing.

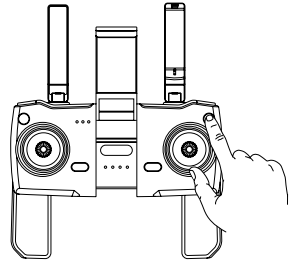

NOTE:

- When **EMERGENCY LANDING MODE** is activated the rotor blades will lock and the Drone will fall to the ground. It is highly recommended that you do not push this button unless it is an emergency.

7.8 DLESS MODE

1. Press the **W/S button** on the remote control (shown in diagram to the right). The remote control will beep once to indicate that headless mode has been enabled. To stop headless mode, press the **W/S button** again; the remote control will beep again.
2. When headless mode is enabled, the Drone will move in the direction of the remote control, regardless of its orientation. This makes it easy to bring the Drone home when it is far away from you.
3. When using headless mode, the camera of the Drone must point in the direction of flight. The back of the Drone should be facing the pilot. See below.

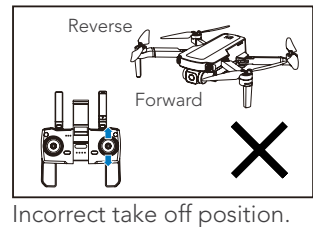
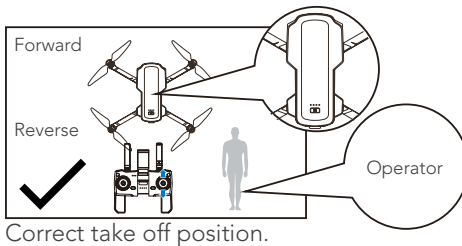
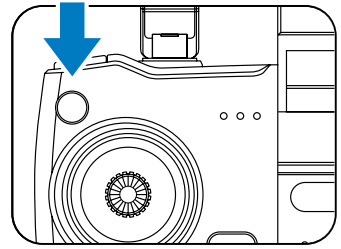

7.9 FLY-AROUND-ME MODE

When activated, FLY-AROUND-ME MODE will make the Drone circle/fly around a selected person or object.

1. To activate FLY-AROUND-ME MODE, while the Drone is in air, aim it at the desired point of interest. Press the **📷 and 📹 buttons** on the remote control simultaneously and it will set the Drone to fly within a radius of 2 to 10 metres.
2. Press the **📷 and 📹 buttons** on the remote control simultaneously again and the Drone will start flying around a point of interest at the radius range you set.
3. Move the right direction control stick to cancel the orbit flight function.

NOTE:

- If the surround radius range is less than 2 metres, the Drone will default to a 2 metre radius for safety purposes.

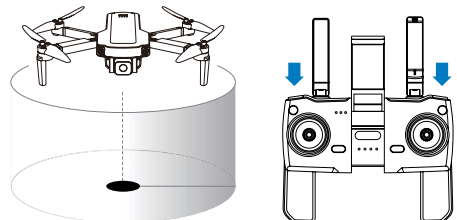

8.0 ZERO- X ESEN APP



The Drone has a built in Wi-Fi connection which is used to wirelessly connect your smartphone to your Drone, thus allowing you to view the cameras live view, trigger recording, and control and fly your Drone.

To connect your smartphone to the Drone please follow the instructions below.

Go to the Google Play store if you are using an Android smartphone, or the Apple App Store if you are using an iPhone and search for the App named "ZX-ASCEND". Once located please download and install the App. Alternatively, please scan the QR code to be taken directly to the relevant App store to download the App.



Connect the App, then go into the Wi-Fi settings on your smartphone and select the connection named ZXMP-ESEN_XXXX (XXXX will be your unique Drone number). Once connected, open the Zero-X Ascend App on your smartphone.

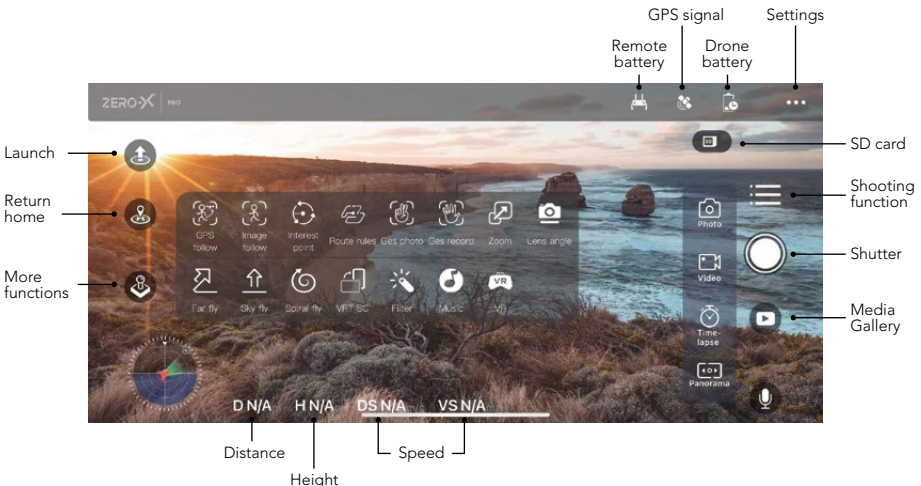
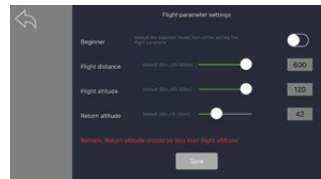

NOTE:

- To launch the Drone, please wait until its status says **"Ready to Fly."** This will ensure that your Drone's GPS has synced successfully. For safety, the default control of the Drone is set to **'Beginner'** where the flight parameters are fixed. To change the parameters, please deselect the beginner mode in the App's flight settings.



9.0 FOLLOW-ME FUNCTION (GPS MODE ENABLED)

With FOLLOW-ME FUNCTION, the Drone will follow your smartphone wherever you go. Please make sure the smartphone is connected to your Drone and the Zero-X Ascend App is installed and opened.

1. Fly the Drone a minimum of 3 metres and maximum 30 metres away from the user.
2. Click the  icon on your App.
3. The App will show **"Follow Me Ready"**, then the Drone will start following the smartphone.
4. Click the  icon again to stop this function.

NOTE:

- FOLLOW-ME MODE depends on the GPS signal. The GPS signal strength can vary depending on several factors: many tall buildings, trees, mobile towers and mobile phone congestion.
- Please fly the Drone in open areas. The Drone is not equipped to avoid obstacles.





9.1 ACTIVE TRACK

The ACTIVE TRACK FUNCTION allows the Drone to follow an object (the object is to be selected via the App).

1. Click the  icon. A square will appear on the App interface. Make a selection around the object you want to track.
2. The Drone will track this object. When the object moves the Drone will move accordingly.

9.2 WAY POINT FLIGHT (GPS MODE ENABLED)

To activate the WAY POINT FLIGHT, the Drone will fly according to the path which you have set. Please make sure the smartphone is connected with your Drone successfully and the App is working. Also make sure that you have downloaded and saved the local map onto your smartphone.

1. Click the  icon on the App, you will see a circle (parameter for flight path) and the Drone's current position on the map.
2. Please mark the points (max 16 points) you plan to fly within the red circle range on the map, and click , then the Drone will fly according to this path.
3. Push the direction stick to stop the way point flight.
4. To reset the flight path, click  or , then click  and you can set a new path again.

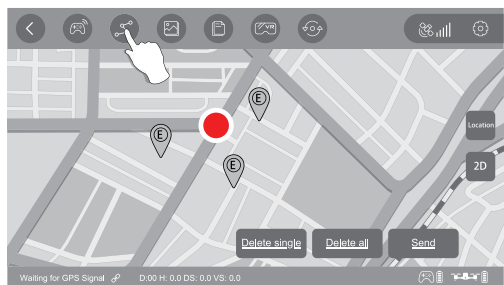

9.3 RETURN HOME (GPS MODE ENABLED)



The **Return Home button** will initiate the automatic landing sequence. Please make sure there are no obstructions, people or animals under the Drone when this is selected.

After pressing the **Return Home button**, it will first elevate and then return back. If the Drone is not connected to the App, please press the **Return Home button** on the controller for the Drone to safely land at the starting point.

9.3.1 SMART RETURN TO HOME

Press the **Return Home button** on your remote control or click the **Return Home icon** on your App and the remote control will start to beep. Your Drone will return to the take off point recorded by its internal GPS. To stop the return to home function, please press the **Return Home button** on your remote control or click the **Return Home icon** on your App again.

9.3.2 LOW BATTERY RETURN TO HOME

When the Drone senses the battery level is low, the Drone will fly back to a place which is about 30 metres from the take off point and you will still be able control the Drone.

When the battery of the Drone is almost empty, the Drone will fly back to the take off point

The Drone will return home if its signal disconnects from the remote control.

NOTE:

- The Drone is not equipped to avoid obstacles.

9.4 PHOTO MODE

Press the **Photo button** on the remote control or click the **Photo icon** on the App. You will see a picture on the App which means the image has been captured. If the Drone is not connected to the App, please press the **TOP LEFT BUTTON (Photo button)** on the remote control to take a picture.

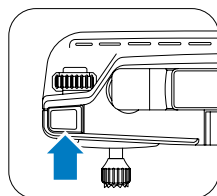

9.5 VIDEO MODE

Press the **Video button** on the remote control or click the **Video icon** on the App. The video recording time will be shown on your App indicating that video is being recorded. If the Drone is not connected to the app, please press the **TOP RIGHT BUTTON (Video button)** on the remote control to take a video.

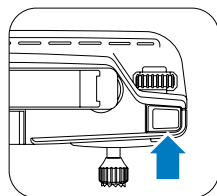

9.6 VIEWING PHOTOS AND VIDEOS

To view your recorded footage and videos you will need to connect the Micro SD card to your computer via either a USB Micro SD card reader or via an SD card converter (not provided). Alternatively, you can click the  icon on your App to view the pictures and videos.

NOTE:

- The quality of videos or photos saved on your smartphone are de-scaled to save space. To save higher resolution videos and photos, ensure you have a Micro SD installed in your drone.

9.7 HAND GESTURE

Click the  icon on the APP, the Drone will take video when the user gestures "👉" and the Drone will take a photo when the user gestures "👆".

10.0 ACTIVATING THE SEARCH FUNCTION FOR A LOST DRONE

1. Press the  icon **3 times** in order to open the map to search for your Drone.
2. The last position of your lost Drone will appear on the map.

11.0 DRONE MAINTENANCE

Avoid exposing your Drone and its accessories to dust, sand and moisture.

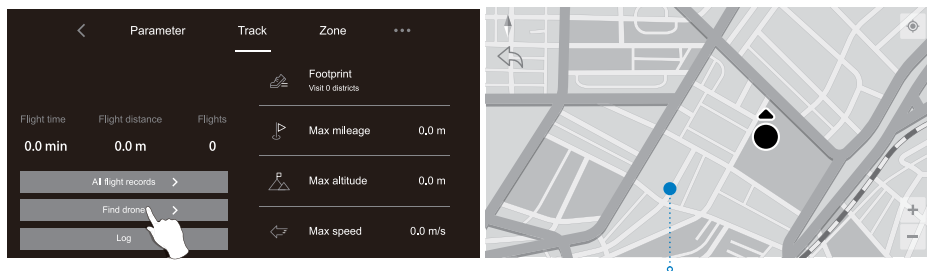

Current position of the Drone.

These elements can damage the Drone. If the Drone is exposed to dust or sand, use a soft brush to remove any visible particles.

12.0 REPLACING ROTOR BLADES

If the rotor blades are damaged, they can be easily replaced with the spare replacement blades.

There are two types of rotor blades included with the Drone. The '**A** blade' (clockwise rotation) and the '**B** blade' (counter clockwise rotation). The blades are marked on bottom showing either **A** or **B**. Please make sure all the blades are fixed in the correct position.

To remove and replace the rotor blades, please follow the instructions below.

1. Unscrew the screw on the side of the rotor blade you want to replace. It is advised that you replace the blades one at a time to avoid losing screws or installing blades incorrectly.
2. Remove the blade by gently pulling the blade away from the motor stem.
3. Replace the rotor blade with a replacement blade and make sure that it matches with the motors.
4. Firmly press the blade into position and make sure that the hole in the rotor blade is aligned with the motor stem.
5. Lock the blade position by tightening the screw that was removed in **Step 1. Do not over-tighten the screw.**

NOTE:

- It is important that the correct rotor blades are installed on the correct motors. If they are installed incorrectly the Drone will not fly and you could potentially burn out the Drone's motors.

13.0 REPLACEMENT PARTS

We understand that it is not always easy learning how to fly a Drone. In rare occurrences, a 'close call' can turn into a crash landing. Accidents happen!

To thank you for your support of Zero-X and your Drone purchase, we would like to help you build your confidence in learning how to fly your Drone by offering you 50% off your first two orders of spare parts.

Simply make your spare parts purchase via our website and use the codes in the coupons to redeem and use your discount.

Visit www.zero-x.com.au | www.zero-x.co.nz to make your purchase.

ZX-DR3BACCW
ZX-DR3BACW
ZX-DR3FACCW
ZX-DR3FACW
ZX-DR3RBS
ZX-DR3USBCBL
ZXMP-D400BAT1500

SPARE PART BACK ARM COUNTER CLOCKWISE
SPARE PART BACK ARM CLOCKWISE
SPARE PART FRONT ARM COUNTER CLOCKWISE
SPARE PART FRONT ARM CLOCKWISE
SPARE PART PACK OF 4 ROTOR BLADES
SPARE PART USB CABLE
ADDITIONAL BATTERY PACK FOR ZXMP-D400 20 MINUTES

THANK YOU FOR YOUR SUPPORT!
PLEASE VISIT OUR WEBSITE AND
USE PROMO CODE:
OOPSIBROKEIT
to receive
50% OFF
your spare parts purchase!

THANK YOU FOR YOUR SUPPORT!
PLEASE VISIT OUR WEBSITE AND
USE PROMO CODE:
OOPSIBROKEITAGAIN
to receive
50% OFF
your spare parts purchase!

14.0 WARRANTY TERMS AND CONDITIONS

Our goods come with guarantees that cannot be excluded under the Australian Consumer Law. You are entitled to a replacement or refund for a major failure and for compensation for any other reasonably foreseeable loss or damage. You are also entitled to have the goods repaired or replaced if the goods fail to be of acceptable quality and the failure does not amount to a major failure.

This warranty is provided in addition to your rights under the Australian Consumer Law. Directed Electronics Australia Pty Ltd (Directed Electronics) warrants that this product is free from defects in material and workmanship for a period of 12 months from the date of purchase or for the period stated on the packaging. This warranty is only valid where you have used the product in accordance with any recommendations or instructions provided by Directed Electronics.

This warranty excludes defects resulting from alterations of the product, accident, misuse, abuse or neglect. In order to claim the warranty, you must return the product to the retailer from which it was purchased or if that retailer is part of a National network, a store within that chain, along with satisfactory proof of purchase. The retailer will then return the goods to Directed Electronics.

Directed Electronics will repair, replace or refurbish the product at its discretion. The retailer will contact you when the product is ready for collection. All costs involved in claiming this warranty, including the cost of the retailer sending the product to Directed Electronics, will be borne by you.

Email: admin@zero-x.com.au

INDEMNITY

You agree to defend, indemnify and hold harmless Zero-X and its subsidiaries and affiliates from and against any and all claims, proceedings, injuries, liabilities, losses, costs and expenses (including reasonable legal fees), including but not limited to, claims alleging negligence, invasion of privacy, copyright infringement and/or trademark infringement against Zero-X and its subsidiaries and affiliates, relating to or arising out of your breach of any provision of these terms, your misuse of Zero-X products or its services, or your unauthorized modification or alteration of products or software.

WARRANTY AND WARRANTY DISCLAIMER

Zero-X has a limited warranty, whereby Zero-X warrants to you and only to you that this Zero-X Action product will be free from defects in materials and workmanship for one (1) year from the date of your purchase (unless a longer warranty period is required by law). The specifics of this Zero-X limited warranty are covered in this manual.

To the extent possible under governing law, other than the above product warranty for the Zero-X Action product you understand and agree that the

Zero-X services are provided on an “as is” and “as available” basis.

Zero-X makes no warranty that the Zero-X product and services will meet your requirements or that use of the Zero-X services will be uninterrupted, timely, secure or error-free. Nor does Zero-X make any warranty as to the accuracy or reliability of any information obtained through Zero-X (including third party content), that any defects in the Zero-X products or services be corrected or that the Zero-X products or Zero-X services will be compatible with any other specific hardware or service.

Further, Zero-X does not warrant that Zero-X products or services or Zero-X servers that provide you with data and content are free of viruses or other harmful components.

Zero-X also assumes no responsibility for and shall not be liable, for any damages caused by viruses that may infect your Zero-X. In the event of any loss, damage or injury, you will not look to Zero-X to compensate you or anyone else. You release and waive for yourself and your insurer all subrogation and other rights to recover against Zero-X arising as a result of the payment of any claim for loss, damage or injury.

Zero-X equipment and services do not cause and cannot eliminate occurrences of certain events, including, and Zero-X makes no guarantee or warranty, including any implied warranty of merchantability or fitness for a particular purpose, that the Zero-X equipment and services provided will detect or avert such incidents or their consequences.

Zero-X does not undertake any risk that you or property, or the person or property of others, may be subject to injury or loss if such an event occurs. The allocation of such risk remains with you, not Zero-X.

Other than the above product warranty for the Zero-X products, its suppliers disclaim all warranties of any kind, whether express, implied, or statutory, regarding the Zero-X services, including any implied warranty of title, merchantability, fitness for a particular purpose, or non-infringement of third party rights.

Because some jurisdictions do not permit the exclusion of implied warranties, the last sentence of this section may not apply to you.

Zero-X hereby further expressly disclaims all liability for any claims for service failures that are due to normal product wear, product misuse, abuse, product modification, improper product selection or your non-compliance with all applicable federal, state or local laws.

This warranty and warranty disclaimer give you specific legal rights, and you may have other rights that vary by state, province, or country. Other than as permitted by law, Zero-X does not exclude, limit or suspend other rights you have, including those that may arise from the nonconformity of a sales contract.

For a full understanding of your rights, you should consult the laws of your state, province, or country. For our Australian customers: Please note that this warranty is in addition to any statutory rights in Australia in relation to your goods which, pursuant to the Australian Consumer Law, cannot be excluded.

LIMITATIONS OF ZERO-X LIABILITY

Under no circumstances will Zero-X be liable in any way for any content, including, but not limited to, the loss of content, any errors or omissions in any content, or any loss or damage of any kind incurred in connection with use of or exposure to any content posted, emailed, accessed, transmitted, or otherwise made available via Zero-X.

Zero-X liability for damages, especially for breach of duty or obligation, delay in performance, non-performance, or malperformance shall be precluded, except when these are due to negligent breaches of any significant contractual duty or obligation on the part of Zero-X. Any liability for negligence is limited to direct losses usually and typically foreseeable in such case. Should the claim for damages be based on wilful or grossly negligent breach of contractual duty or obligation on the part of Zero-X, the preclusion and limitation of liability mentioned in the preceding sentences will not apply. The preceding preclusion and limitation of liability will also not apply to claims for damages arising out of loss of life, bodily injury or health impacts for which Zero-X may be liable, or for non-contractual liability.

Some states and countries do not allow the exclusion or limitation of incidental or consequential damages, so the above limitation or exclusion may not apply to you. Additionally, this provision is not intended to limit Zero-X's liability in the event of Zero-X's wilful or intentional misconduct.

Capture the skies.™



www.zero-x.com.au | www.zero-x.co.nz



All Images, Information and Content are Copyright © 2024
Directed Electronics Australia Pty Ltd. All Rights Reserved.

www.directed.com.au | www.directed.co.nz

© Zero-X v1.0 2024